

Selection Guide | VLT® HVAC Drive FC 102

Drive down operating costs with the HVAC efficiency leader



98%

Energy efficiency

Save energy and
money with HVAC
drives



Contents

The best in HVAC is now better than ever.....	4
Efficient climate solutions for commercial buildings and infrastructure.....	5
Nothing beats know how and experience.....	10
Savings throughout your entire lifecycle.....	11
Guaranteed operation in your application.....	12
Integrated intelligence.....	13
Intelligence for Air Handling Units & Rooftop Units ..	14
Intelligence for Fire & emergency operation.....	15
Intelligence for fan applications	16
Intelligence for pumps	17
Achieve maximum availability of your system	
– with condition-based monitoring	18
Drive as a controller.....	20
Installed efficiency	
Enjoy ongoing returns	21
Ecodesign	22
EC+ concept	22
Back-channel cooling:.....	23
Efficient and economic heat management	23
A master of all motor technologies	24
Installation made simple	
Save mounting time and cost.....	25
Optimize performance and grid protection.....	27
Save commissioning time with SmartStart	28
Wireless connectivity to the drive	29
Customize to improve user experience.....	30
Access the drive remotely	31
Built to last – in the toughest environments.....	32
Modular simplicity – A, B and C enclosures.....	34
High-power modularity – D, E and F enclosures.....	36
Extended functionality for high-performance operation – Enclosed Drives	38
Harmonic mitigation – invest less and save more.....	40
Convenient and fast	
– Digital tools empower you.....	43
DrivePro® Life Cycle services.....	44
Connection example.....	46
Technical data.....	47
Enclosure overview A, B and C.....	48
Electrical data – A, B, and C enclosures.....	49
Dimensions enclosure sizes A, B and C.....	51
Ordering type code for A, B and C enclosures	52



Dedicated drive for highest **energy efficiency** and **reliability**

The VLT® HVAC Drive FC 102 is a dedicated, globally supported drive that combines flexibility and efficiency in a package designed to minimize total system and lifecycle costs in HVAC applications.

The VLT® HVAC Drive is the preferred AC drive for heating, ventilation and air conditioning systems throughout the world. Designed to be installed in any fan or pump system and efficiently operate induction, permanent magnet, and high-efficiency synchronous reluctance motors, you can count on the VLT® HVAC Drive to provide years of reliable, maintenance-free operation.

The Danfoss EC+ concept pairs the VLT® HVAC Drive with high-efficiency motor technologies, with efficiency classes of IE3 and above. EC+ provides building owners with a flexible and future-proof system that is able to meet and exceed increasingly stringent environmental and efficiency-focused legislation in a cost effective way.

Every VLT® HVAC Drive is based on 30 years of experience and innovation. Easy to use, all models follow the same basic design and operating principle. The portfolio of drives offers enormous breadth and depth, but no matter which drive you choose, once you know one, you know them all. This selection guide helps you to choose and configure your perfect drive for applications in the range 1.1-1400 kW.

Enclosure overview D, E and F	53
Electrical data – D, E and F enclosures.....	54
Dimensions enclosure sizes D, E, and F.....	56
Electrical data and dimensions – VLT® 12-Pulse.....	57
Ordering type code for D, E and F enclosures	58
Electrical data & dimensions	
– VLT® Low Harmonic Drive and	
VLT® Advanced Active Filters	60
Electrical data for Enclosed Drive	62
Dimensions for Enclosed Drive	63
Ordering type code for Enclosed Drive enclosures....	64
A options: Fieldbuses	66
B options: Functional extensions.....	67
C options: Relay card	68
D option: 24 V back-up power supply	68
Power options	69
Accessories	70
Accessory compatibility with enclosure size	72
Loose kits for enclosure sizes D, E and F	74



IM
Three-phase
induction motor
with copper rotor



LSPM
Line-start PM motor
with buried magnets
and rotor cage



SynRM
Synchronous
reluctance motor



IPM
PM motor with
buried magnets



SPM
PM motor with
surface-mounted
magnets



The **best** in HVAC is now **better than ever**

As the world's population continues to increase, energy-optimized HVAC systems are the key to providing comfort and safety without increasing energy consumption. Even extreme climates and isolated outposts have a need for efficient HVAC operation. To give you the flexibility you need with the reliability you expect, the VLT® HVAC Drive has been enhanced to meet your needs – and more.

Enhanced efficiency

New motor technologies are driving an increase in operating efficiency, especially in HVAC applications. To get the most out of these permanent magnet (PM) and synchronous reluctance (SynRM) motors, you need an AC drive equipped with the algorithms to most optimally control these motors.

Enhanced connectivity

HVAC applications can be found everywhere, with installations in isolated areas of the world or in difficult-to-access locations. This requires new ways of thinking in order to efficiently communicate to these drives.

Integrate the VLT® HVAC Drive seamlessly to practically any building automation control network. Web servers provide even more ways to connect to your drive, securely and remotely. Web servers integrated in the Ethernet™ options provide for even more ways to securely and remotely connect to your drive.

Built to last

The VLT® HVAC Drive series is designed with ruggedized enclosures to resist harsh ambient conditions with temperature and humidity extremes. Furthermore its high-quality components provide at least 10 years reliable operation under normal operating conditions, with no component replacement.

Comprehensive portfolio

- Standalone drives
 - Low-power range: 1.1-90 kW
 - High-power range: 110-1.4 MW
- Enclosed drives: cabinet-mounted drives with harmonic & EMC filters

Small investment – big returns

New energy efficiency regulations focus on ways to reduce energy consumption and CO₂ emissions. To meet these new standards, adding an AC drive is a necessity. Over the lifetime of an AC drive, energy cost is the dominating economical factor, but savings can be found in other associated costs.

Selecting the VLT® HVAC Drive provides the lowest total cost of ownership. Installation and commissioning take less time, and operating efficiency is higher than for other comparable drives.

Total cost of ownership is mainly defined by the operational cost. Therefore operational costs are the most important factor in selecting a new drive.

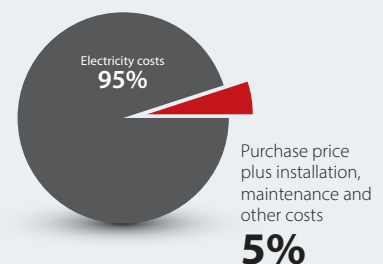

Go outdoors with
extreme-climate
performance from
+55 °C down to

-25°C

Efficient climate solutions for commercial buildings and infrastructure

- Driving performance to the next level

Commercial buildings and infrastructure, where people work and travel, and where costly technology is installed, must provide a safe and healthy indoor climate that allows occupants - as well as equipment - to perform at their best.

Offering the lowest total cost of ownership in the market, a Danfoss Drives solution will continue to pay itself back multi-fold throughout its entire lifecycle. Virtually maintenance-free, optimized operation of the HVAC installations in your building

means that, for many years, you can simply keep counting your wins on all parameters; from user-friendly operation to system reliability, carbon footprint, energy savings and productivity.



A breath of fresh air for productive environments

Offices, schools, sports arenas – facilities occupied by people must provide a safe and healthy indoor climate for its occupants. VLT® HVAC Drive ensure that buildings are supplied with fresh air and at the optimal temperature for everybody to focus and perform at their very best.

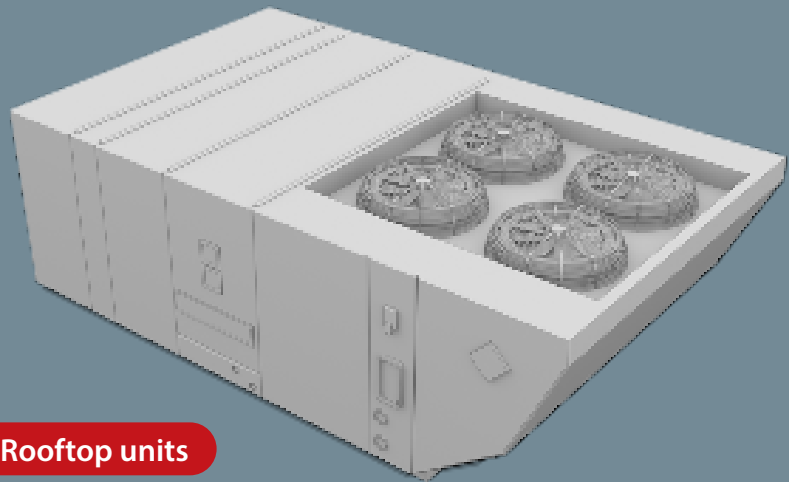

Rooftop units

Cool tech for optimal performance

Danfoss AC drives applied to air recirculation fans in the data center control the air flow between the racks. Removing excessive heat around the IT installations, they ensure optimal thermal conditions to protect electronic components and enable optimal performance of the servers.

Maximize uptime

- Maintain optimal temperature around IT installations
- Extend the life span of your equipment
- Keep energy costs down

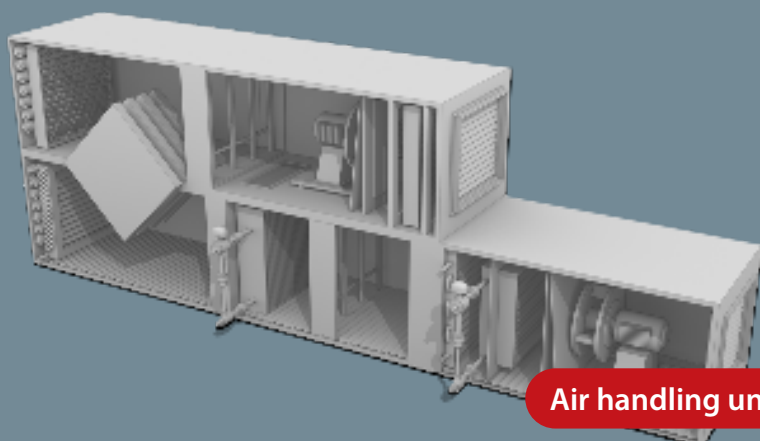

Air handling units

Energy-lean performance

Danfoss AC drives enable you to optimize energy efficiency, never compromising on the safety and comfort for the occupants of your building.

The lowest Total Cost of Ownership (TCO) in the market

- Adapt capacity to actual demand
- Reduce operating costs
- Reduce wear and tear on your installations

Evacuate safely from buildings and tunnels

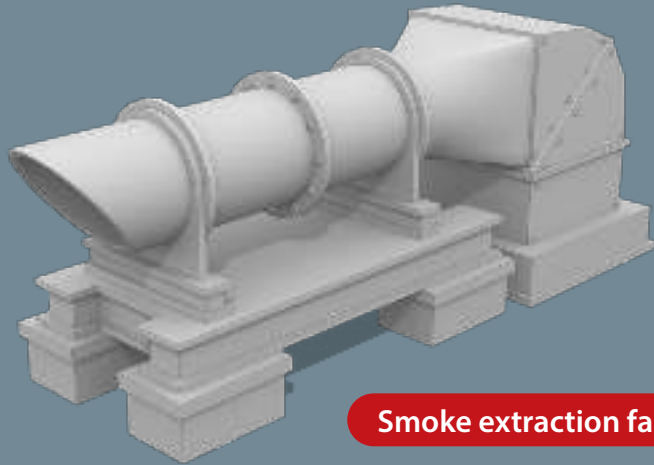

Smoke extraction fans

Safeguard transport hubs

Fire safety is a top priority when ensuring the comfort and safety of staff and passengers in transport hubs. As well as increasing precision, saving energy and extending application lifetime of the entire HVAC system, VLT® HVAC Drive is designed to keep smoke extraction fans running, no matter what.



Underground health and safety

Danfoss AC drives work with the complex HVAC systems in underground subway and train services as well as road tunnels. Providing reliable operation of cooling, ventilation and safety systems, our solutions ensure pollution-free and safe environments for millions of passengers the world over.

Protect commuters and staff

Our drives provide a reliable smoke extraction system that reacts independently to multiple zones as needed, to support the safe evacuation of commuters and staff in the event of a fire.

A less complex and more reliable system

- Ensures continued operation of smoke extraction fans in the event of a fire
- Multi-zone feature allows for independent speed controls

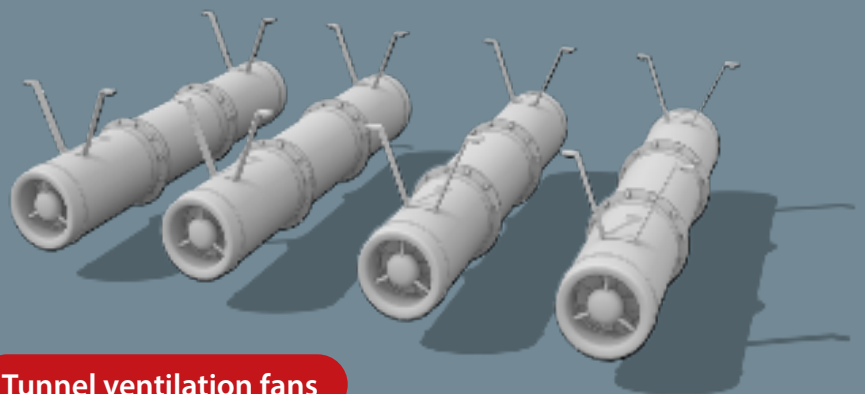

Tunnel ventilation fans

Take the heat off your air conditioning budget

Optimizing energy efficiency, speed control enables tremendous savings - without compromising on occupants' well-being - and minimizes Total Cost of Ownership (TCO).

Ultimate cost efficiency

- Adapt capacity to actual demand
- Reduce wear and tear
- Reduce maintenance costs

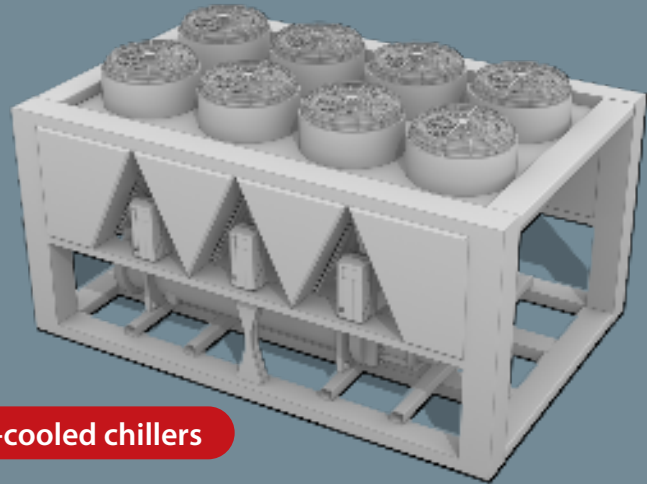

Air-cooled chillers

When drives are operation critical

Danfoss AC drives enhance and support the operation and reliability of complex hospital HVAC systems. Regulating air flow, humidity and temperature, they ensure patient and staff comfort and safety – also in the event of fire – while optimizing conditions in operation rooms and wards.

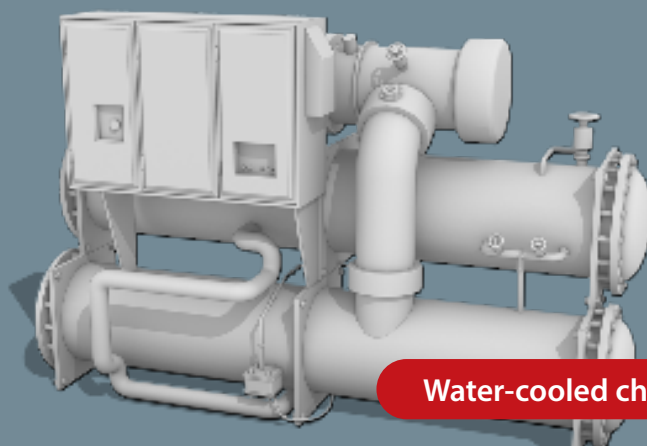

Water-cooled chillers

Stay in your comfort zone

Danfoss AC drives enable tremendous savings, without compromising the comfort or the well-being of staff and shoppers spending their day in the mall.

Ultimate cost efficiency

- Adapt capacity to actual demand
- Reduce wear and tear on the system
- Reduce maintenance costs

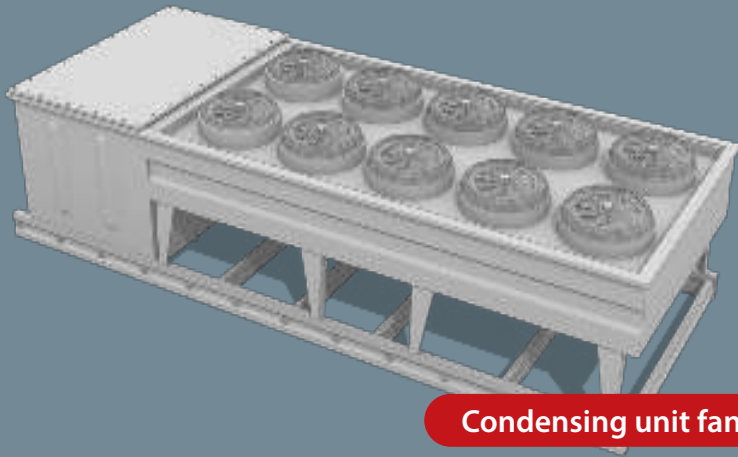

Condensing unit fans

Stay cool!

You can rest assured that Danfoss AC drives will keep your operation running smoothly, while contributing to considerable savings on your energy bill, and never compromising on indoor comfort.

Reliable and efficient operation

- State-of-the-art multi-motor control and monitoring feature
- Optimal energy efficiency
- Outdoor enclosure ensures full reliability with temperature extremes from -25 °C to +55 °C



Top flight performance

Ventilation and air conditioning are top priority when ensuring the comfort and safety of airport passengers and staff - including fire safety. Danfoss AC drives increase precision, save energy and extend application lifetime of the entire HVAC system.

Dedicated to precision and protection

Reliable operation of the building infrastructure is key to providing a consistently healthy indoor climate to keep customers and staff happy and safe.

Pump-dedicated control features

- Optimize your operation
- Maintain perfect thermal conditions
- Keep your energy bill at an absolute minimum

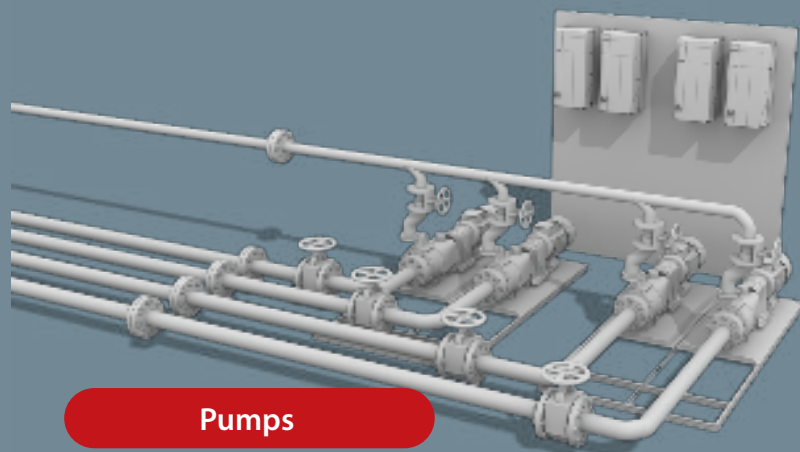

Pumps



Nothing beats know how and experience
VLT® HVAC Drive is built to **deliver**
the **ultimate cost efficiency**

Total cost of ownership

A variety of costs come into play when looking at the total lifecycle of your AC drive. From time spent gathering specifications and engineering the solution, to the purchase price, to installation, commissioning, operation and maintenance costs, the VLT® HVAC Drive has the perfect mix of quality and features to ensure these costs are minimized over the life of the AC drive.

Reliability

AC drives in HVAC applications see some of the most extreme aspects of the environment. From the frozen tundras to the scorching deserts, VLT® HVAC Drives are exposed to a wide range of operating temperatures. Additionally, AC drives are often used in areas of the world where seismic activity is common or where they are exposed to potentially corrosive atmospheres. You can count on the VLT® HVAC Drive to continuously operate in all of these conditions.

HVAC expertise

Applications in HVAC are extremely well positioned for energy savings, resulting in reduced energy costs and lowering a building's carbon footprint. New, more efficient motors being used in these applications require unique motor control algorithms in order to optimize their operation. Enabling the user to program their VLT® HVAC Drive in terms commonly used in the HVAC industry ensures that the AC drive is quickly commissioned and always operating with optimal efficiency.

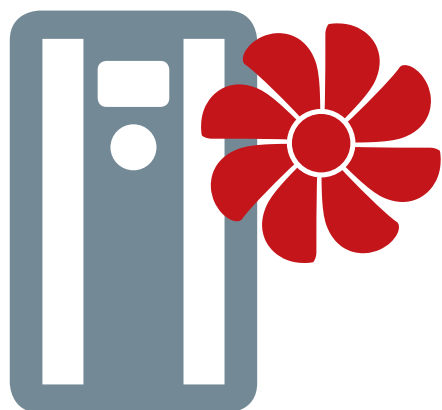

**Total
cost of
ownership**

Reliability

**HVAC
expertise**

Know-how and experience
Proven quality
DrivePro® Services

Savings throughout your entire lifecycle

When you partner with Danfoss, your savings start from the moment you consider installing a VLT® HVAC Drive in your application. Access to electrical and mechanical drawings, early in the design phase. Easy installation, commissioning, and operation of the drive.

An AC drive that efficiently operates your motor. And 24/7 service and support to ensure trouble-free operation of your application.

Energy efficiency

Energy efficiency of the AC drive includes more than the drive itself. Through a combination of minimizing thermal losses, low standby power consumption and a demand-based cooling fan, the VLT® HVAC Drive operates at 98 % efficiency.

Optimal motor control

Efficiency is very much based on which motor is best suited for your application. Whether you use an induction motor (IM), a permanent magnet motor (PM) or a synchronous reluctance motor (SynRM), you can be certain that your VLT® HVAC Drive will provide reliable, accurate motor control. Using Automatic Motor Adaptation (AMA) and Automatic Energy Optimization (AEO) functions further ensures that your motor is always operating as efficiently as possible.

User friendliness

Installation, commissioning and maintenance can be some of the most time and cost-intensive steps in the life cycle of an AC drive. To minimize the impacts of these steps, the VLT® HVAC Drive features a common control panel that includes SmartStart application guides, HVAC-specific parameter names, spring loaded I/O terminals, easy-to-access power and motor terminals. Smart wireless connection alternatives using app or web server make it easy to connect via the device of your choice.

Fieldbus availability

The ability to easily integrate your AC drive into your building automation system is a key to optimal control. The VLT® HVAC Drive features a number of HVAC-specific communication protocols, such as BACnet/IP, that allow for a great level of flexibility of installation in both new and existing building automation systems.

Personalize your drive

The VLT® Software Customizer optimizes drive personalization, allowing you to customize parameter names, alarms and warnings, configurable application-specific SmartStart guides, and even a custom display screen for the control panel to brand your company or improve customer information.

Additionally, where there's a high level of commonality in the application and parameter settings, a unique set of customer specific initial values (CSIV) can be defined. This CSIV can then be loaded in the drive, replacing the factory default values with the customer specified default values.

Total cost of ownership

5

reasons to choose the VLT® HVAC Drive

1. Energy efficiency
2. Optimal motor control
3. User friendliness
4. Fieldbus availability
5. Personalize your drive



Total
cost of
ownership

Reliability

5

reasons to choose the VLT® HVAC Drive

1. Quality
2. Environment
3. Uptime
4. Electrical immunity and EMC
5. Global 24/7 support

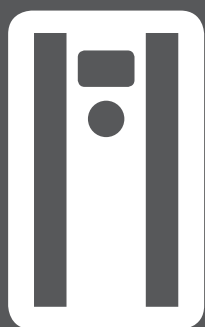

Reliability

Guaranteed operation in your application

These days, your HVAC applications are often challenged by temperature fluctuations, seismic activity, areas with high levels of atmospheric pollutants, unstable grid quality or a mixture of these conditions. Knowing this, the VLT® HVAC Drive has been equipped to give you the tools to meet these challenges and more. Day in and day out, wherever you face them, you'll have an AC drive that you can always rely on.

Quality

Our goal has always been to provide you with products and systems of the best possible quality, functionality and efficiency. To improve our service to you even further, we have implemented the ISO/TS 16949 standard. This standard builds on the previous ISO 9001 guidelines but is far more ambitious in scope, addressing not just what we should do but how we should do it. The TS 16949 standard is about understanding your needs and meeting them with products, solutions and services that match your expectations.

Environment

With a wide operating temperature down to -25 °C and up to 55 °C and an availability of enclosure classes up to IP66/UL Type 4X, the VLT® HVAC Drive can operate almost anywhere even outdoors. The addition of seismic resistance, the ability to install to altitudes of 2000 m/6500 ft without derating and options for conformal, harsh environment coating to 3C3, further improves the VLT® HVAC Drive's ability to work in the most demanding environments.

Uptime

The drive is an important part of air-handling and rooftop units. With billions of people all around the world relying on these HVAC systems for comfort and safety, one of the key focuses is selecting an AC drive that can withstand unforeseen grid fluctuations that would otherwise interrupt operations. To improve ride-through, the VLT® HVAC Drive relies on a robust

overvoltage controller, kinetic backup and flying start which ensures reliable operation when it's needed most.

Electrical immunity and EMC

Electrical events occurring in the grid can cause serious issues for AC drives and systems. SEMI 47 certification is your documentation for reliable drive performance, despite voltage spikes and dips. The VLT® Advanced Harmonic Filter program deals with harmonics challenges in the grid and guarantees mitigation below 5 % THDi.

The drive is also short-circuit proof, with a 100 kA prospective short circuit current capability to protect it against damage.

Integrated EMC filters meet the requirements of Residential Categories C1 and C2 with up to 150 m screened motor cable. These filters also minimize radio-frequency interference (RFI) to even further protect sensitive equipment from radiated emissions.

Global 24/7 support

Expect minimum 10 years' reliable drive operation with no scheduled component replacement, under normal operating conditions. Should you need any kind of support, any time, at any location, we will be there for you. We understand that your uptime is critical, and we react fast.



Learn more about DrivePro® Life Cycle service offerings

Integrated **intelligence**

When searching for the best AC drive for your application, you want to find a partner that understands your needs and challenges. With over 30 years dedicated to HVAC applications, we've heard your comments and continually added the most requested features. As a result of your close cooperation, the VLT® HVAC Drive is a drive that speaks your language, is reliable enough to be installed where you need it, and saves you time and money throughout its lifetime.

Safety

HVAC applications require a wide and varying consideration for safety in order to protect both the people around the equipment and the equipment itself. To aid this, the VLT® HVAC Drive features the integrated Fire Mode function and a series of options for basic and advanced functional safety, ATEX certified inputs and a lockable mains disconnect as part of the enclosure.

Drive as a controller

Unleash the intelligence of your drive. Via its Smart Logic Controller, the drive offers a multitude of sophisticated control functionalities you can put to work to reduce complexity, optimize cost and achieve next-level performance in your HVAC applications. Customize the process control exactly to your application. VLT® Pressure Transmitter PTU 025 and a wide range of control options extend control functionality where required.



Learn more about intelligent control

Condition-based monitoring

Use the intelligent VLT® HVAC Drive to monitor the condition of your motor and application in real time, detect when current operation status is drifting away from the defined limits, and alert the operator to changes before they impact your process.



Learn more about condition-based monitoring

Digital design tools

Almost all owners and operators of AC drives aim to reduce the amount of energy used in their applications. That's why understanding and documenting energy savings and energy efficiency are vital steps in engineering a system - and in measuring its performance once up and running. Use the Danfoss digital tools and intelligence built into the drive, to support your engineering and document performance:

VLT® EnergyBox tool calculates the potential energy savings of the system in the design phase, based on logged real-life operation data.

MyDrive® ecoSmart tool calculates and documents the efficiency class of both the drive and system according to IEC/EN 61800-9.

A built-in energy meter measures the energy consumed by each drive in your application.



Learn more about digital tools

Resource library

Design your system faster with access to diverse resources including 3D BIM files.

HVAC expertise

5

reasons to choose the VLT® HVAC Drive

1. Safety
2. Drive as a controller
3. Condition-based monitoring
4. Digital design tools
5. Dedicated HVAC functionality



HVAC expertise

Intelligence for Air Handling Units & Rooftop Units

Master control for AHU or RTU

VLT® HVAC Drive includes intelligent features enabling you to program the drive to control a complete Air Handling Unit (AHU) or Rooftop Unit (RTU). The Smart Logic Controller (SLC) with 4 parallel control loops makes it easy to program monitoring and control loops in a simple way without additional cost. For more advanced control, let the VLT® Programmable Controller option take over the controls. Program the LCP for specific user dialogue. Use external I/Os to extend and match the required number of I/Os in an advanced AHU or RTU controlled by the drive.

Pressure to flow conversion

A flow controller integrated into the drive ensures a defined flow or pressure level in the air supply system. Using the built-in VLT® Pressure Transmitter PTU 025 you achieve a cost-optimal intelligent AHU control system, with optimized energy consumption, reduced system complexity, and improved comfort.

Air Filter Monitoring

Intelligent filter monitoring maintains the perfect indoor climate at a low operating cost. The operator can define his own warning levels for clogged filter replacement, and the monitoring level is adjusted according to the fan speed. The intelligent VLT® Pressure Transmitter is factory-calibrated and monitors up to 4 filters simultaneously. This option features 3 pressure ranges from 500 Pa to 2500 Pa. Attach it easily and directly to the VLT® HVAC Drive with no need for additional external equipment.

Extended BMS capacity

Easy integration into building management systems (BMS) provides managers with detailed information about the current state and operation of the infrastructure in the building. All the I/O points in the drive are available as remote I/O to extend the capacity of the BMS. Pressure signals from the PTU 025 function as external I/O modules connected via the communication interface.



VLT® HVAC Drive equipped with VLT® Pressure Transmitter PTU 025

This innovative solution fulfils the Ecodesign Directive ErP, EC Regulation 1253/2014/EG to improve AHU/RTU energy consumption.



Read the fact sheet



Pressure/Speed curve settings

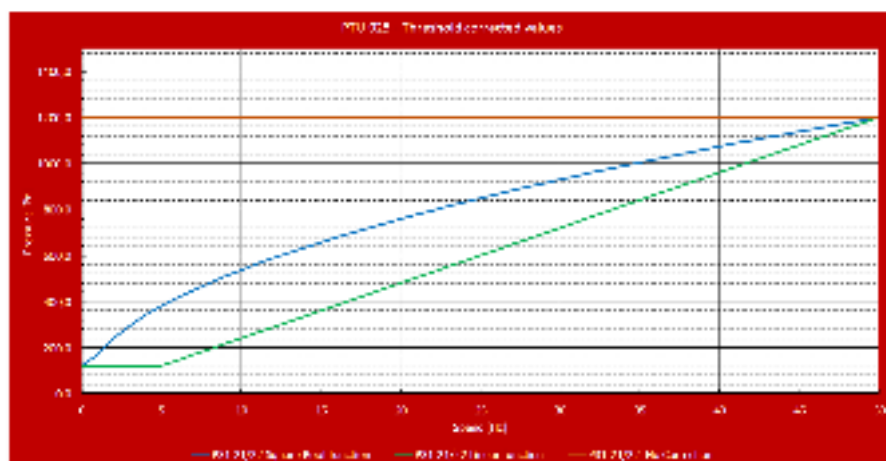

Intelligent HVAC features

- Controls AHU or RTU air flow from inlet to outlet
- Flow control based on pressure level or air volume
- Smart Logic Controller with 4 loops in parallel
- Optional programmable controller
- Extended I/O for BMS integration, internal & external
- Integrated VLT® Pressure Transmitter PTU 025 with filter monitoring

Intelligence for Fire & emergency operation

Fire and emergency

In the event of fire in a building, the Fire Emergency Mode safety feature prevents the drive from stopping to protect itself. Instead it will continue vital fan operation to secure optimal smoke extraction or over-pressure in the stairwell to ensure occupants can more safely evacuate buildings via staircases.

Continual monitoring of the fire system installation, including the motor, also ensures optimal operating conditions when a critical situation arises. This eliminates potential interruptions to starting the fire system, such as a motor service switch or a broken cable installation. This kind of continual monitoring may also reduce the frequency of service checks required. Run the drive on normal operation settings, where Fire Emergency Mode will suppress alarms. Alternatively change to special Fire Emergency Mode settings, with up to 32 different operation settings in 4 setup groups.

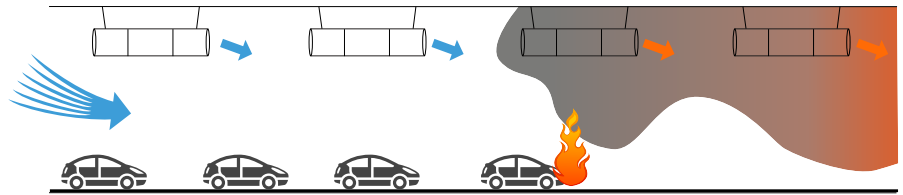

Smoke extraction and Multi-zone Fire-mode

The VLT® HVAC Drive also features a multi-zone fire-mode function that allows for adjustable speed controls depending on the zone(s) where the fire is active. Utilizing the logic within the drive allows for a less complex and more reliable smoke extraction system that can respond to multiple zones according to need.

Multi-zone Fire-mode is based on 8 setpoints in 4 setup menus to support forward and reverse directions, and open-loop or closed-loop control. Activate Multi-zone Fire-mode via digital input or via fieldbus.

Use it confidently in buildings as well as carpark and tunnel systems, where the multi-zone control and change of operation condition support secure and coordinated control of ventilation and smoke extraction systems for heightened safety of occupants.



Intelligent HVAC features

- Special operation condition for best protection of human life: “Run to dead” suppresses drive self-protection alarms
- Reduce fire development via standard ventilation systems or by controlling special smoke extraction systems
- PID control maintains “over pressure” in stairwells to keep them smoke-free, and to ensure people can enter the stairwell from the different floors
- Use normal operation condition or switch to special operation setting with up to 32 different zones in 4 setups
- Control via fieldbus or standard I/O to adapt to different fire system solutions
- Continue operating at full load* for minimum 1 hour at 70 °C ambient temperature. *80 % load for high-power drives
- Continuous monitoring of the installation to ensure reliable operation when a critical situation arises
- Operation log documents Fire Emergency Mode operation and alarms, including service guidelines for any critical alarm activated
- Supports EN 12101 standard for smoke and heat control systems



Intelligence for **fan applications**

Embedded fan function

The VLT® HVAC Drive FC 102 includes more features than any other drive, to increase efficiency and deliver a trouble-free operation with high performance in all HVAC applications.

Speed bypass to avoid resonance

The drive avoids resonance problems using a built-in function to bypass speed ranges where the application may generate resonance. The bypass speed range is defined by a start and stop speed for bypass activation. It supports up to 4 speed ranges, based on a RPM or Hz selection.

No load / Broken Belt warning

Many fan applications are still operated by a belt. This function monitors whether the belt is still in use, has ceased operation due to wear and tear. The built-in maintenance program helps you to ensure belt inspection at regular intervals.

Multi-Motor

One drive can handle a number of induction motors in a multi-motor configuration, often defined as a “fan wall”. This means that one VLT® HVAC Drive operates all of the connected motors at the same frequency and with the same voltage. Special selection and configuration is required to ensure safe operation of the motors and the application.

Drive bypass¹⁾

If a drive bypass is available the VLT® HVAC Drive will not only sacrifice itself; it will also bypass itself and connect the motor directly to mains. As a result fan functionality will be maintained after the drive stops operating, as long as there is still power and the motor is functioning.

¹⁾Only available in the USA

Auto tuning of PI controllers

Auto tuning enables the drive to monitor how the system reacts to corrections made by the drive constantly. The drive learns from it and calculates the P and I values, so precise and stable operation is restored quickly.

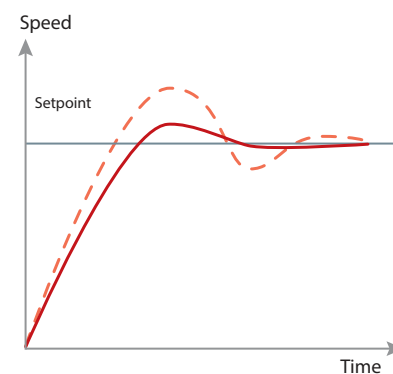



Intelligence for pumps

Embedded pump controller

The Pump Cascade Controller distributes operation hours evenly across all pumps. Uneven wear and tear on individual pumps is therefore reduced to a minimum, extending their lifetime expectancy and reliability considerably.

Vital water supply

If a pipe leaks or breaks, the VLT® HVAC Drive can reduce the motor speed to prevent overload, while continuing to supply water at lower volume.

Sleep mode

In situations with low or no flow, the drive enters sleep mode to conserve energy. When the pressure falls below the pre-defined setpoint, the drive starts automatically. Compared to continuous operation this method reduces energy costs and equipment wear and tear, extending the lifetime of the application.

Auto tuning of PI controllers

For details, refer to page 16

Dry pump protection and end of curve

If the pump runs without creating the desired pressure, the drive sets off an alarm or performs another pre-programmed action. This happens for example when a well runs dry or a pipe leaks.

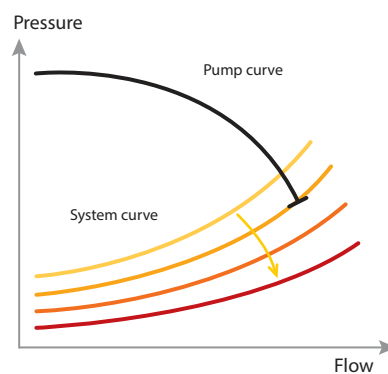

Flow compensation

A pressure sensor mounted close to the fan or pump provides a reference point maintaining constant pressure at the discharge end of the system. The drive constantly adjusts the pressure reference to follow the system curve.

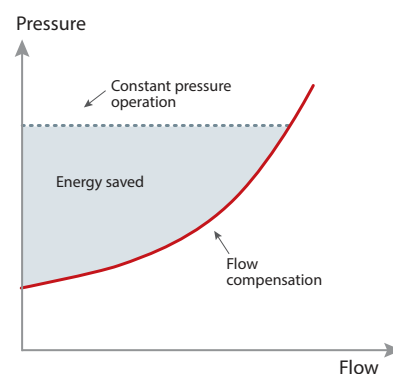

No/low flow

During operation, a pump normally consumes more power the faster it runs. In situations where the pump runs fast, but is not fully loaded, and does not consume adequate power, the drive compensates accordingly. This is a particular advantage when water circulation stops, the pump runs dry or when pipes leak.

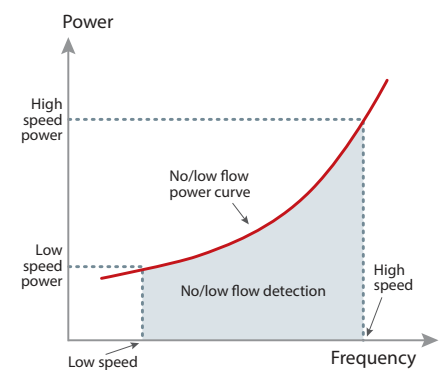

Sensorless Pump control

Sensorless Pump Control enables the drive to generate the pressure or flow based on a defined or measured pump curve inside the drive.

This process works with non-compressible liquid and no additional sensors are required.

The drive can communicate its sensorless data to an external process controller, when relevant.



Intelligent
 monitoring and
 maintenance
 functions embedded
 in the drive

Achieve maximum availability of your system – with **condition-based monitoring**

Equipped with intelligent monitoring functionality, the VLT® HVAC Drive enables you to use the drive as a smart sensor. It can monitor the condition of your motor and application in real time, detect when current operation status is drifting away from the defined limits, and alert the operator to changes before they impact your process.

Condition-based monitoring

During installation, the condition-based monitoring (CBM) function establishes a baseline defining the recorded operation conditions for each monitoring element of the system, and threshold values are defined. During operation, CBM monitors motor stator windings, sensors and load-envelope conditions, all adjusted according to the actual speed of the system. When actual operation conditions exceed the defined limits, CBM sends alerts to notify personnel to take action.

The CBM function complies with relevant standards and guidelines, such as

- ISO 13373 standard for Condition Monitoring and Diagnostics of Machines
- VDMA 24582 guideline for condition monitoring
- ISO 10816/20186 standards for measurement and evaluation of mechanical vibration.

The unique embedded functionality means that the VLT® HVAC Drive performs CBM monitoring inside the drive. When required, activate cloud or PLC connectivity to enable monitoring of numerous conditions or to send alerts when required.

Feature	Benefit
Condition-based monitoring functionality embedded in the drive	<ul style="list-style-type: none"> - No cloud connection required: high security level and no subscription fee - Reduced installation costs, since no external controller or PLC required to generate the CBM observation and notification - Documentation of system stability
Motor-stator-winding monitoring	<ul style="list-style-type: none"> - More uptime due to early detection and action on faults in the motor stator winding, before the fault develops into a crippling failure and unscheduled operational stop
Load-envelope monitoring Application baseline (run / online)	<ul style="list-style-type: none"> - Process optimization/maximized efficiency thanks to ability to compare actual system performance with baseline data and trigger maintenance actions
Sensor application monitoring (external) Application baseline (run / online)	<ul style="list-style-type: none"> - More uptime due to early detection and action on signs of mechanical misalignment, wear-out and looseness - Higher precision since sensor monitoring relates to motor speed



Read the white paper here

Motor-stator-winding condition monitoring

Motor-winding failures do not occur suddenly; they develop over time. They start with a small single-turn shortcircuit fault which causes additional heating. The damage then spreads to a level where the overcurrent protection activates, and the operation stops, causing unwanted downtime.

The unique winding condition monitoring function allows you to shift from reactively performing corrective maintenance of faulty motors, to proactively detecting motor isolation faults at an early stage and dealing with them during scheduled maintenance. In this way, you can avoid unwanted and potentially costly machine downtime caused by 'burned' motors.

Sensor selection

Four condition-based monitoring sensor inputs are defined by the analogue inputs. Using condition-based monitoring parameterization, you can scale the inputs to monitor the sensor signals where the vibration sensor is the most commonly used sensor type. Pressure and flow sensors could also be selected, provided that sensor selection is related to the drive speed of the system.

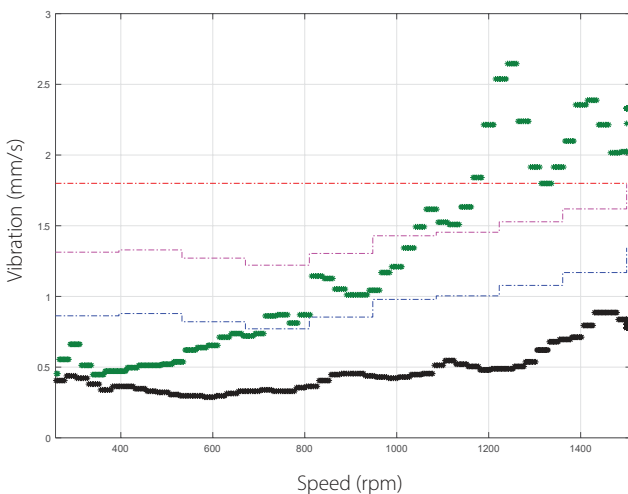

Application example showing changes in vibration signal

- Baseline data
- Faulty data
- - - Alarm Level
- - - Warning Stage 2 Level
- - - Warning Stage 1 Level

Mechanical-vibration monitoring

Avoid accelerated wear of the mechanical parts of a drive system by using CBM together with an external vibration transducer, to monitor the vibration level in a motor or application, related to the actual speed or rotation of the system.

Vibration monitoring is performed using standardized methods and threshold levels given in standards such as ISO13373 for Condition Monitoring and Diagnostics of Machines or ISO10816/20816 for Measurement and Classification of Mechanical Vibration.

Baseline measurement of min/max and average values indicate the stability of a system at different speeds and are very useful as a hand-over test from contractor to end-user.

Load-envelope monitoring

Use the VLT® HVAC Drive to compare the actual load curve to the initial values determined during commissioning. This empowers you to detect unexpected operating conditions, such as

- leakage in an HVAC system. Inadequate or excessive power consumption indicates a problem, defined at individual speeds.
- pumps which have become fouled or sanded
- clogged air filters in ventilation systems

When a part has worn out, the load curve changes compared to the initial baseline, and a maintenance warning is triggered allowing you to quickly and effectively remedy the issue. Load-envelope monitoring can also help you to save energy by ensuring the equipment always runs in optimal conditions.

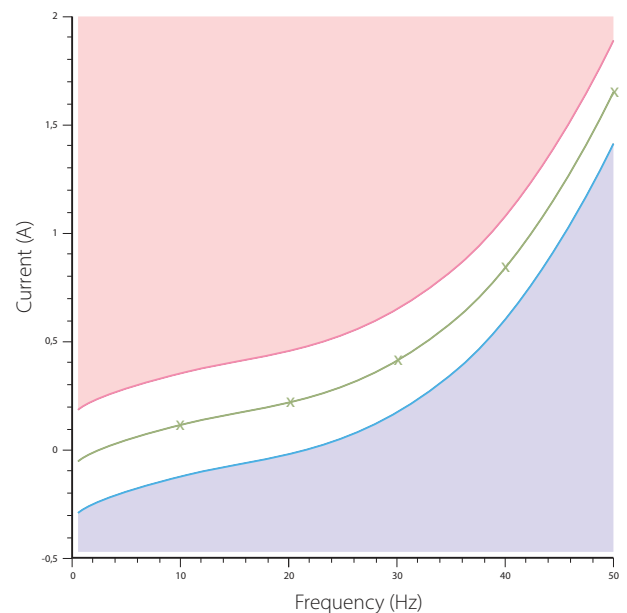

Baseline - Load envelope monitoring of energy consumption.

- Energy consumption above the limit
- Energy consumption below the limit



Drive as a **controller**

Customize with SLC

Use the built-in Smart Logic Controller (SLC) to customize drive functionality, and optimize how the drive, motor and application work together. The VLT® HVAC Drive features 4 different SLC loops which operate independently. Create new functions via simple, intuitive drop-down selections that give you numerous options for setting the drive to specific application needs. Most logic functions run independently of the sequence control, meaning the drive monitors variables or signal-defined events in an easy and flexible way, independently of the motor control.

Use freely programmable options and I/O modules to increase the control area of the drive even more.

Use these programmable options to control air handling functions with fans, valves and dampers to reduce and free up valuable control capacity for the building management system. Advanced local programmability and programming of the LCP for user interaction reduces the overall complexity of an AHU/RTU installation, and future-proofs it, ready for IoT and cloud integration.

Time-based functionality and real-time clock

Integrated date, day and time-based functionality means you can easily program the drive to change operation mode, start functions or even make specific actions, right on time. The real-time clock option ensures you are always in control of the time and date - even after power cycling of the drive.

Functional safety

The VLT® HVAC Drive is able to provide the STO (Safe Torque Off) function in compliance with ISO 13849-1 PL d and SIL 2, according to IEC 61508 / IEC 62061. Optional integrated lockable mains disconnect protects staff working inside the HVAC installation.

Extended I/O

Extend the I/O interfaces using a wide variety of options to match application needs, such as standard digital I/O and relays; analog I/O, and special interfaces for temperature sensors. Connect the extensions inside the drive enclosure or via a bus system to external I/O modules, with protection ratings IP20 to IP66.

Drive as I/O interface in remote installations

The ruggedized enclosure of the VLT® HVAC Drive makes it possible to install the drive fully exposed to a harsh environment: close to the motors, sensors, and other control components. The drive I/O interface and control functions reduce installation complexity. The drive connects directly to all the local components in the installation, and connects via fieldbus to the BMS system or other SCADA systems which control the complete application.

Local I/O connection covers a variety of interfaces: the built-in I/O functions, and optional internal and external I/O modules via BACnet or Modbus. These installations are often used in tunnel projects or in renovation projects where standalone systems are integrated into a larger BMS which monitors the application.

PID controllers & autotuning

Four proportional-integral-derivative (PID) controllers are built into the drive to ensure optimal internal and external control and to eliminate the need for auxiliary control devices. The PID controllers maintain constant control of closed loop systems enabling the drive to adjust motor speed to regulate pressure, flow, temperature or other system requirements.



Installed efficiency – **Enjoy ongoing returns** on your drive investment each year

VLT® HVAC Drive delivers superior energy savings using a unique combination of strategies which include intelligent control algorithms, heat management, and harmonic mitigation.

These valuable energy savings are a result of our tight focus on energy efficiency, including the highly economical solution for harmonic mitigation and an outstanding cooling concept that considerably reduces or completely eliminates the need for air conditioning. Compared to traditional drive solutions, the savings made possible with the VLT® HVAC Drive exceed the energy savings gained by choosing an IE3 motor instead of an IE2.

Energy saving heat management

A unique back-channel cooling concept transfers up to 90% of heat away from the room, using a fan-less design that exploits heat differentials in materials and air temperature and the latest developments in heat piping technology. This results in large energy savings on air conditioning.

 *Learn more about back-channel cooling*

Energy efficient harmonic mitigation

The unique VLT® Low Harmonic Drive with integrated Advanced Active Filter delivers energy efficiency that is 2-3% better than traditional AC drives with Active Front End technology. Sleep function at low load ensures further energy savings.

Advanced Automatic Motor Adaption

The VLT® HVAC Drive will automatically adapt to the motor to ensure supremely efficient motor performance, no matter which brand or type of motor technology you choose for your facility. The VVC+ control automatically performs advanced motor data analysis for optimum and highest efficiency control.

 *Learn more about intelligent control*



AHRI - directory of Certified Product Performance

Automatic adaption to application

Around 90% of all motors are oversized by more than 10%. Automatic Energy Optimizing functionality can deliver energy savings of 2-5% over the whole load range.

Validate performance of your drives using digital tools

- **MyDrive® ecoSmart™** calculates IE and IES classes according to EN 61800-9-2
- **MyDrive® Harmonics** calculates harmonics mitigation requirements and recommends solutions
- **VLT® EnergyBox** calculates and monitors the energy savings achievable by using VLT® drives

 *Learn more about digital tools*



EC+

concept for superior
system efficiency

Ecodesign and EC+ concept

Ecodesign and generation of power efficient systems

The Ecodesign is based on international IEC standards (IEC/EN 61800-9) to document the efficiency of a power drive systems and thereby reduce the energy consumption of systems. Save energy by combining a high-efficiency Danfoss drive with a high-efficiency PM motor.

Use the MyDrive® ecoSmart tool for guidance and documentation of the optimal drive selection for any motor type in a power drive system application.



ecosmart.danfoss.com



Ten things you need to know about Ecodesign



Learn more about digital tools

EC+ concept

Motors with permanent-magnet rotors are increasingly popular due to their high efficiency. In the HVAC sector, this technology is primarily known as an "EC motor". EC motors operate on the basis of the brushless DC motor (BLDC) principle and they are typically used in external-rotor fans with low air throughput.

However Danfoss offers a more efficient control concept, named EC+. EC+ concept is based on high-efficiency PM motors combined with drives running the VVC+ control algorithm for optimal system efficiency.

An EC+ concept system normally offers higher efficiency, since axial fans consume much less energy, and generate a higher air throughput than EC fans. Furthermore, the design of these PM motors is based on the IEC standard for motor mechanical construction – making it easier to upgrade an existing system.



Learn more about EC+ concept

Advantages of the EC+ concept

- Free choice of motor technology: control a SynRM, PM or induction motor with the same AC drive
- Device installation and operation remain unchanged
- Manufacturer independence in the choice of all components
- Superior system efficiency thanks to a combination of individual components with optimum efficiency
- Retrofitting of existing systems is possible
- Wide range of rated powers for SynRM, PM and induction motors.



85%
system efficiency

System efficiency increase:

- Axial fans with up to 92 % efficiency
- Highly-efficient PM motor with efficiency up to 95 %
- VLT® HVAC Drive with up to 98 % efficiency



Read how Volkswagen uses EC+ concept

Back-channel cooling: Efficient and economic heat management

The Danfoss back-channel cooling system is a masterclass in thermodynamics that delivers efficient cooling using a minimal amount of energy.

Cost-saving heat management

A compact design that exhausts 90% of system heat outside the building makes it possible to reduce the size of your cooling system in the panel or switch room. These remarkable savings are achieved with Danfoss' panel-through cooling system or the extremely efficient back-channel cooling concept. Both methods considerably reduce the installation costs of the panel or

switch room, as designers can shrink the size of the air conditioning system, or even eliminate it entirely. In daily operation, the benefits are equally clear as the energy consumption related to cooling is brought down to an absolute minimum. Combined installation and energy savings result in up to 30 % cost savings in the first year of your drive investment.

Revolutionary design

The proprietary back-channel cooling concept available for the VLT® HVAC Drive is based on a unique heatsink design, with heat pipes that conduct heat 20,000 times more efficiently than traditional solutions. Using a minimal amount of energy, the concept exploits the heat differentials in materials and air temperature to effectively cool high performing electronics.

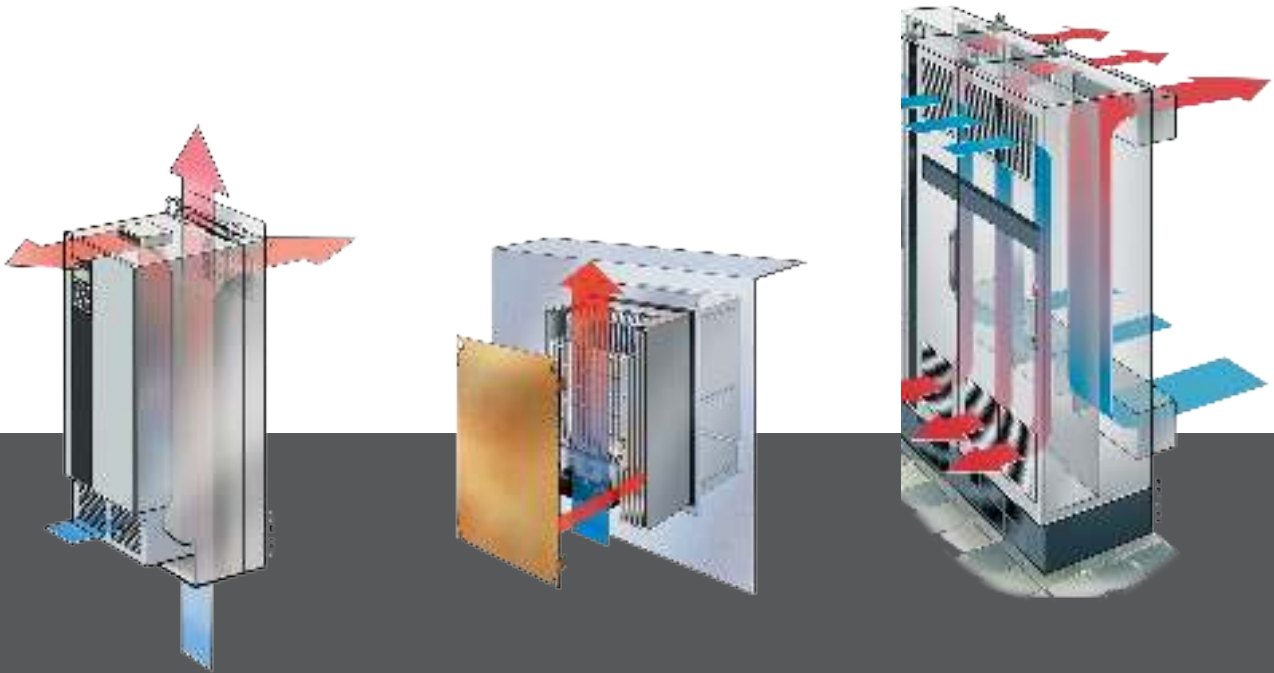

90% reduction in air conditioning system investment
90% reduction in energy use for air conditioning

1 Reduced dust over electronics

Complete separation between cooling air and internal electronics, ensures trouble-free operation and longer intervals between service.

2 Panel-through cooling

An accessory mounting kit for small and mid-range drives enables heat losses to be directed directly outside the panel room and into designated air ducts.

3 Back-channel cooling

By directing air through a rear cooling channel up to 90 % of the drive's heat loss is removed directly outside the installation room.

A master of all motor technologies

Save commissioning time and fine-tune for optimal system control. The choice of motor is all yours - use VLT® HVAC Drive with the motor technology you prefer.

Free choice of motor

Danfoss gives you a free choice of motor supplier and supports all commonly used motor types. The VLT® HVAC Drive offers control algorithms for high efficiency and trouble-free operation with standard induction motors, permanent magnet (PM) motors, induction and synchronous reluctance motors. This means you can combine a VLT® HVAC Drive with your favorite motor technology to achieve a masterclass performance.

Straight into action with Automatic Motor Adaption

Allowing you to access optimal, dynamic motor performance with just a few clicks, the AMA function saves you a lot of time and effort when setting up the system. Guided by the SmartStart start-up wizard, just enter the basic motor data, such as currency and voltage, which are found on the motor name plate, and you are straight into action.

Motor control for general & advanced applications

The drive uses standard VVC+ motor control, an easy and perfect choice for most variable torque HVAC applications. However in some circumstances, the more advanced Flux mode motor control is required to gain faster motor control of the application and to handle unstable mains power supply. Advanced Flux control also demands a higher degree of alignment of the motor parameters for optimal control, where the AMA function helps to create the best operation platform.

Automatic Energy Optimization

With the AEO feature we have made a complex task easy and available with only a few clicks. The integrated AEO function ensures optimal energy-efficient speed control of the pump, while adapting the voltage exactly to the current load situation to reduce energy consumption.

Super-easy commissioning with Auto Tuning

Auto tuning fine-tunes your system to optimal performance, while cutting down on programming. The auto tuning function measures a series of system characteristics and automatically finds the settings of the process controller for stable and precise system control.

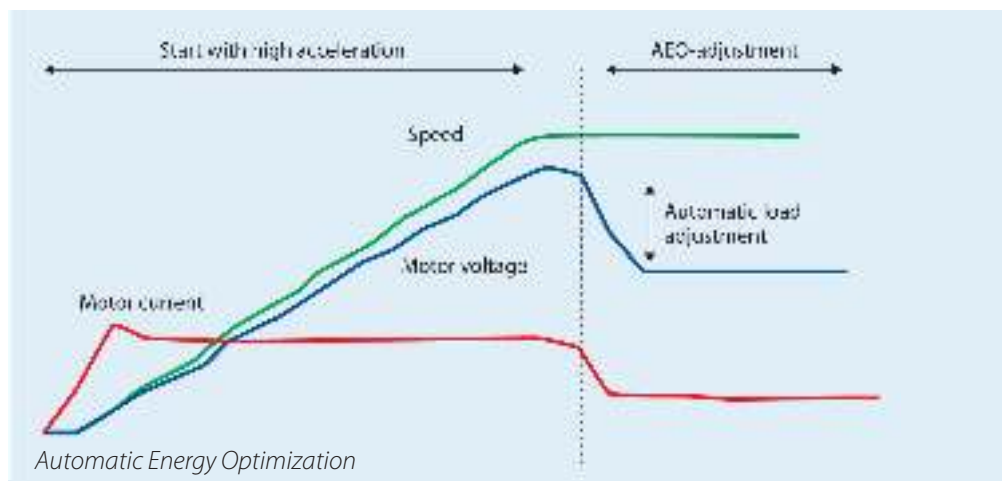

This panel features five motor technology icons arranged in two rows. Each icon is a circular cross-section of a motor, with its name and a brief description below it.

- IM**: Three-phase induction motor with copper rotor
- LSPM**: Line-start PM motor with buried magnets and rotor cage
- SynRM**: Synchronous reluctance motor
- IPM**: PM motor with buried magnets
- SPM**: PM motor with surface-mounted magnets

Installation made simple

– Save mounting time and cost

The VLT® HVAC Drive is built on a flexible, modular design to provide an adaptable compact solution which is also simple to install. Reduced complexity and clever practical details save installation costs and time.

Reduce costs with compact drives. **Danfoss offers the highest power density in the market.**

Compact design and efficient heat management enable the drive to take up less space in control rooms and panels in various environments. Combined with side-by-side installation capability, the VLT® HVAC Drive delivers superior space-saving drives solutions. Especially impressive is the 400 V version, which is among the smallest in its power class on the market today, and is available in an IP54 and IP66 enclosure.

Direct from factory for outdoor installation

VLT® HVAC Drive is ready in any protection class that you require for your HVAC operation, from IP20 for panel mounted solution to IP66/NEMA 4X for outdoor installation, for example where drives are installed on a rooftop unit (RTU).

Extended temperature range

Tolerance of a wide operating temperature range, from -25 °C to +55 °C, means you can install the drive locally in outdoor HVAC operations. This decentral installation capability reduces cable costs and eliminates the need for air conditioning, lowering cost of electrical rooms.

Long cable capability

With no need for additional components, the VLT® Drive provides flexible installation with cable lengths up to 150 m screened and 300 m unscreened to reduce installation costs. An with an All-Mode filter up to 1000 m with standard unscreened cables.

Built-in EMC filters

VLT® HVAC Drive units are equipped with integrated DC link chokes and EMC filters as standard features. This enables them to reduce grid pollution and eliminate the cost and effort of fitting external EMC components and related wiring. A regular electrician can install the drive easily in residential areas, with no need for a professional installer.

Space-saving harmonic mitigation

The Danfoss enclosed drives or a central Advanced Active Filter (AAF) solution for harmonic mitigation keeps installation costs down, while reducing the size of the drive cabinet to save space in the electrical control room.

Easy commissioning

Whether it's a 1.1 kW or a 1.4 MW drive, you get the same control panel with local language, the new SmartStart function and many other time-saving features, all wirelessly accessible from your mobile device to save you installation time and hassle.





Optimize performance and grid protection

Built-in protection

The AC drive contains all the modules necessary for compliance with EMC standards.

A built-in, scalable RFI filter minimizes electromagnetic interference, and the integrated DC link chokes reduce the harmonic distortion in the mains network, in accordance with IEC 61000-3-12. Furthermore, they increase the

lifetime of the DC link capacitors and therefore the overall efficiency of the drive.

These built-in components save cabinet space, as they are integrated in the drive from the factory. Efficient EMC mitigation also enables the use of cables with smaller cross-sections, which reduces installation costs..

Expand grid and motor protection with filter solutions

Danfoss' wide range of solutions for harmonic mitigation ensures a clean power supply and optimal equipment protection, and includes:

- VLT® Advanced Harmonic Filter AHF
- VLT® Advanced Active Filter AAF
- VLT® Low Harmonic Drives
- VLT® 12-pulse Drives

Provide extra motor protection with:

- VLT® Sine-wave Filter
- VLT® dU/dt Filter
- VLT® Common Mode Filters
- All-Mode filters

Achieve optimum performance for your application, even where the grid is weak or unstable.

Use motor cables up to 1000 m

The design of the AC drive makes it a perfect choice in applications that require long motor cables. Without needing additional components, the drive provides trouble-free operation with cable lengths of up to 150 m shielded or 300 m unshielded. Extend the cable length to 1000 m with unshielded motor cables by using a All-mode filter solution. This allows the drive to be installed in a central control room, away from the application without affecting motor performance.

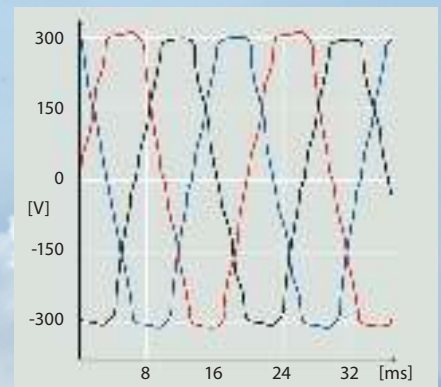

Harmonic distortion

Electrical interference reduces efficiency and risks harming equipment.

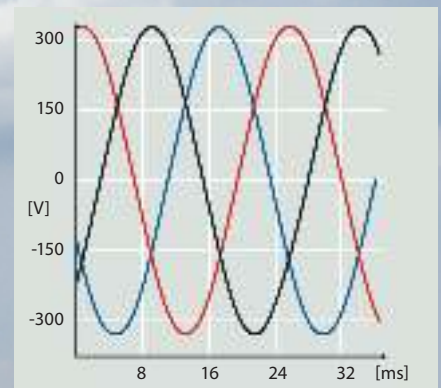

Optimized harmonic performance

Efficient harmonic mitigation protects electronics and increases efficiency.

EMC Standards		Conducted emission		
Standards and requirements	EN 55011 <i>Facility operators must comply with EN 55011</i>	Class B Housing and light industries	Class A Group 1 Industrial environment	Class A Group 2 Industrial environment
	EN/IEC 61800-3 <i>Converter manufacturers must conform to EN 61800-3</i>	Category C1 First environment, home and office	Category C2 First environment, home and office	Category C3 Second environment
Compliance ¹⁾		■	■	■

¹⁾ Compliance to mentioned EMC classes depends on the selected filter. For further details see the design guides.

Installation made simple

– Wireless connectivity to the drive

Wireless connection to the drive via your smartphone makes commissioning and troubleshooting easier and faster when drives are outdoor protected and located in hard-to-access spots.

The VLT® Wireless Communication Panel LCP 103 communicates with MyDrive® Connect – an app which you can download to iOS and Android-based smart devices. MyDrive® Connect gives you full access to the drive, making it easier to perform commissioning, operation, monitoring and maintenance tasks.

Instant access to vital information

The VLT® Wireless Communication Panel LCP 103 displays the current drive status (On, Warning, Alarm, Wi-Fi Connectivity) through built-in LEDs. Via MCT 10 on a laptop or via the MyDrive® Connect app you can then use your smart device to access detailed information, such as status messages, start-up menus and alarm/warning events. This means you can configure your drive wirelessly on IP55 and IP66 without compromising the tight enclosure for USB connection.

The app will also visualize various data with graphs to document the behavior of a drive over time. Utilizing the active point-to-point wireless connection or via an access point and local network, maintenance personnel can receive real-time error messages via the app to enable quick response to potential issues and reduce downtime.

Sharing data

The advanced LCP copy function allows you to store copies of the drive parameters, either to the internal memory of the VLT® Wireless Communication Panel LCP 103 or to your smart device. Log details can be shared from MyDrive® Connect, so that the service team can provide relevant support for troubleshooting. The safe control parameter allows the user to decide the drive behavior in case of crash/connection-loss from app to drive.



Free to connect

Real time information is becoming increasingly important in building management systems (BMS) as well as industrial applications with Industry 4.0. Immediate access to data increases transparency in production facilities, while making it possible to optimize system performance, collect and analyze system data and provide remote support around the clock from anywhere in the world.

Today, drives are more than simple power processors. With the ability to act as sensors and sensor hubs, to process, store and analyze data, along with connectivity capabilities, drives are vital elements in modern BMS and

automation systems using Industrial IoT. This means Danfoss drives are valuable tools in **condition monitoring**.

Regardless of your application or your preferred communication protocol, Danfoss drives have an extremely wide variety of communication protocols to select from. In this way you can ensure that the AC drive integrates seamlessly into your chosen system providing you the freedom to communicate however you see fit.

Increase productivity

Fieldbus communication reduces capital costs in production plants. In addition to the initial savings achieved

through the significant reduction in wiring and control boxes, fieldbus networks are easier to maintain, while providing improved systems performance.

User friendly and fast set-up

Danfoss fieldbuses can be configured via the drive's local control panel, which features a user friendly interface with support for many user languages. The drive and fieldbus can also be configured using the software tools that support each drive family. Danfoss Drives offers fieldbus drivers and PLC examples for free from the Danfoss Drives website to make integration to your system even easier.



Customize to improve user experience

Make the VLT® HVAC Drive your own

The VLT® HVAC Drive masters all the world's most commonly-used languages and you can easily make it speak the language of your own specific installation. The VLT® HVAC Drive gives you a wealth of options for setting your drive up to serve your specific application or customer needs.

Customizer - plain language communication

Whether you are an end user or an OEM, our customization options allow you to make the drive your own for easy commissioning and trouble-free operation. The Customize feature tailors your solution precisely to your users' language, to inform and guide them optimally for the best operation of the application:

- Choose the parameters that are most important to show in the display for your operation.
- **Reduce commissioning time.**
 - We have carefully selected the initial values with the typical user in mind. But it is also possible to enter your own values* and save them as factory settings for a particular application segment.

- Set up your own start-up wizard to customize the drive for your users. No programming required, you simply and intuitively drag and drop to select your parameters.
- Splash-Screen; import your logo from a jpg or any other commonly used file type to have your own name featured on the display.
- Make the drive speak your application's language by naming terminals according to functions.
- **Manage access.**
 - The VLT® HVAC Drive allows for several password functions with various ways of locking access and allocating user rights.
 - Simulate the LCP

Hassle-free trouble-shooting with user-defined alerts

Make error codes a thing of the past with user-defined alerts that make any system warning understandable to any user. When the drive speaks application language, rather than drives language, service technicians can get guidelines straight from the display and immediately take the action required.

**CSIV - customer-specific initialization values*

Communication interfaces

The VLT® HVAC Drive offers you a diverse range of communication interfaces:

- The integrated LCP, which is still the most common way to interact with the drive
- Fieldbus communication to a Building Management System (BMS) is a major trend. However user interaction for optimizing the drives in the application is often forgotten, and here the VLT® HVAC Drive can fulfill the need well
- Wireless communication using LCP 103 for commissioning and service purposes
- Access management. A BMS will often limit the options for unauthorized change of operation settings, however the VLT® HVAC Drive has a built-in password management system which can serve this function



Digital tools

Danfoss offers a range of digital tools you can use to customize, communicate with, or monitor the drive.

- **VLT® Software Customizer**
- **MyDrive® Connect**
- **VLT® Motion Control Tool MCT 10**

 Learn more about digital tools

Access the drive remotely

Commission and operate the drive either locally via the LCP or remotely using the MyDrive® Connect tool. Today it is common to connect drives via a fieldbus system or a wireless network connection, for convenient access from a remote location.

Connect via wireless network

Use the VLT® Wireless Control Panel LCP 103 to create a Wi-Fi network for direct access between a smart device and the drive, or via an access point where multiple smart devices can access the drive, one at a time.

The MyDrive® Connect app shows the drives that are accessible on the network, each displayed with a user-defined name created in the parameter settings.

Both LCP 103 and MyDrive® Connect give you full access to all information inside the drive. You can change parameter settings and control the drive to start and stop remotely.

Integrated webserver in Ethernet-based fieldbuses

A webserver interface is available in all Ethernet-based VLT® fieldbus options. Using a standard browser, you can access the drive after entering the correct IP address and password. This interface is perfect for smartphone, tablet and desktop screens, where the webserver supports a variety of different browser interfaces.

Which information you can access is pre-defined in menus and widgets to improve the user experience.

These data include the normal status information of the drive (readout, I/O, Alarm Log, Trend charts, statistics), and maintenance and energy efficiency information and trends.

You can also subscribe to e-mail notifications from the drive, when an e-mail server is connected to the same network.

Cloud-based solution for smart buildings

Generate IoT and smart cloud solutions to suit your needs. In the HVAC industry a “smart building” trend with MQTT connection is gradually replacing conventional BMS systems, where a master BMS controller is in control of all the building applications. The new approach is towards a multitude of “sub-master” systems, each of which controls the operation of a smaller application.

A good example of the sub-master approach is to use VLT® HVAC Drive to control a complete AHU. Then different control systems can access the drive

directly to incorporate the complete AHU into the new generation of BMS solutions. One of the expert systems may focus on comfort in the building, a second system on the energy consumption, and a third system deal with maintenance and filter replacement.

Danfoss offers drives solutions with the ability to support these different cloud solutions, with built-in security at a very high level to secure the connection between the drive and the “broker” and cloud- servers; all depending on the internet-cloud concept that the user has selected.

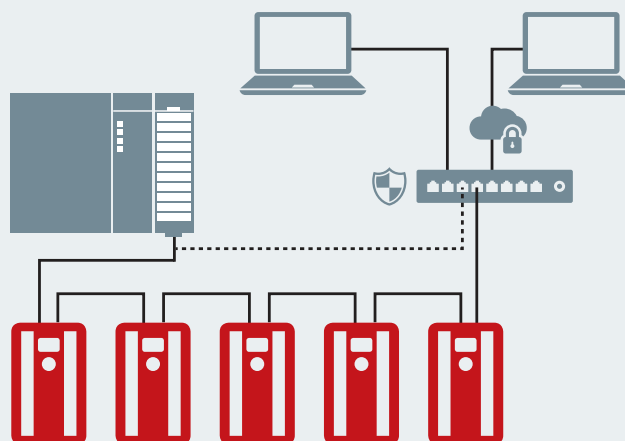

Web server dashboard



Built to last

– in the toughest environments

Danfoss designs and develops product for real-life applications, meeting tough challenges to ensure trouble-free operation. VLT® HVAC Drive components are selected to guarantee a long operating lifetime. Internal sensors and integrated maintenance software support many years' straightforward operation.

Design for 10+ years operation between part replacements

High quality components are selected for use in the design of the VLT® HVAC Drive, in order to ensure minimum 10 years normal operation before first replacement of service components. A built-in maintenance program helps you to monitor the drive installation, to ensure the drive operates within its specification. A service plan covers the maintenance and service of vital elements essential to the safe operation of the application. After the first 10 years, replace only a few components before commencing the next 10+ years of reliable operation.

Built for the environment

The VLT® HVAC Drive can operate almost anywhere, even outdoors. Enclosure protection ratings from IP 20 up to IP66/UL Type 4X mean the drive resists the most demanding of installation conditions with a standard enclosure. Its wide operating temperature specification from -25 °C to +55 °C reflects the extreme strength of this product design.

The VLT® HVAC Drive conforms as standard to class 3C2 (IEC 60721-3-3), and options for conformal, harsh environment coating to 3C3 are available. The drive is available in a 'ruggedized' version to ensure that components remain firmly in place in applications characterized by high vibration levels, such as marine and mobile equipment. All these factors work together to ensure the ability of this drive to run reliably in the most demanding environments.

Smart software increases uptime

The drive is an important part of AHU/RTU systems for comfort and safety. One of the key priorities in drive selection is high resistance to unforeseen grid fluctuations that would otherwise interrupt operations. To improve ride-through, the VLT® HVAC Drive relies on a robust overvoltage controller, kinetic backup and an improved flying start which ensures reliable operation when it's needed most.



3C3

Coated PCBs as standard in all high-power drives

Manufacturing matches the highest standard in automotive

Intelligent product design is key to ensuring long and trouble-free operation of the drive in the application. The manufacturing process must meet the highest of standards to ensure reliability and strong product performance.

To improve our service to you even further, we have implemented the ISO/TS 16949 standard in our factory. This standard builds on the previous ISO 9001 guidelines but is far more ambitious in scope, addressing not just what we should do, but the processes behind how we should do it. The ISO/TS 16949 standard is about understanding your needs and meeting them with products, solutions and services that match your expectations. Danfoss factories follow the highest manufacturing standards and many processes are managed by robots, to fulfill our aim of a zero-failure production.

Designed to protect

Intelligent algorithms ensure that the drive continues to operate as expected, despite spikes and dips in voltage. The drive is SEMI F47-certified to document its performance. The drive is SEMI F47-certified to document its performance.

Because the drive may be connected to a system that experiences a short circuit which could potentially destroy the connected drive, the VLT® HVAC Drive is designed to be short-

circuit-proof with a 100 kA prospective short circuit current capability for reliable operation, no matter what the challenge.

The drive enclosure completely separates cooling air and the internal electronics to protect them from dust-borne contaminants. Efficient heat removal helps prolong product life, increases the overall availability of the system and reduces faults related to high temperatures.



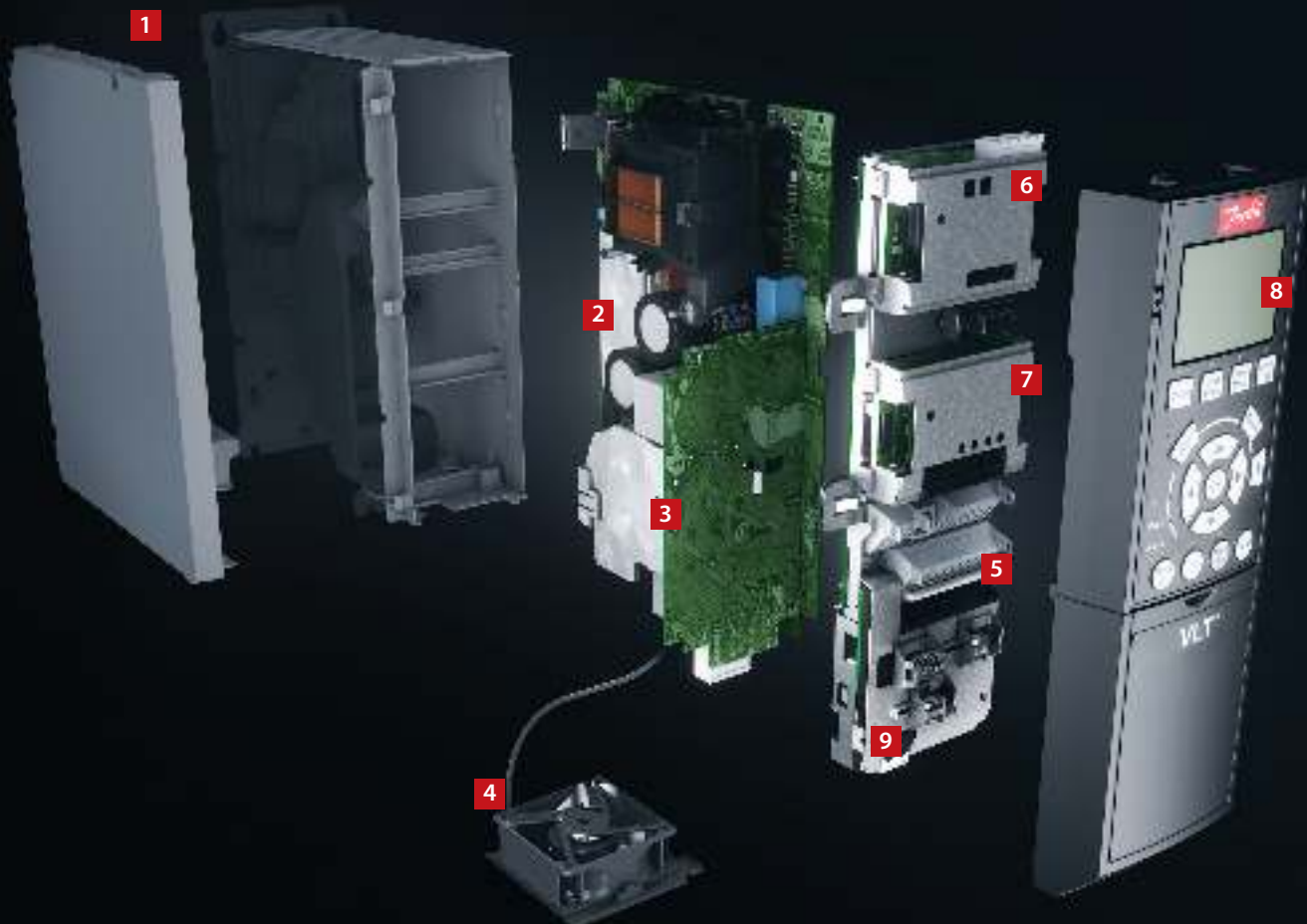

Modular simplicity – A, B and C enclosures

Delivered fully assembled and tested to meet your specific requirements

1. Enclosure

The drive meets requirements for enclosure class IP20/Chassis. IP21/UL Type 1, IP54/UL Type 12, IP55/UL Type 12 or IP66/UL Type 4X.

2. EMC and Network effects

All versions of VLT® HVAC Drive comply as standard with EMC category C1, C2 and C3 after IEC 61800-3 (A1, A2 and B after EN 55011) limits B, A1 or A2 according to the EN 55011 norm and IEC61800-3 Category C1, C2 and C3. The standard integrated DC coils ensure low harmonic load on the network according to EN 61000-3-12 and increase the lifetime of the DC link capacitors.

3. Protective coating

The electronic components are, as standard, coated as per IEC 60721-3-3, class 3C2. For harsh and aggressive environments, coating as per IEC60721-3-3, class 3C3 is available.

4. Removable fan

Like most of the elements, the fan can be quickly removed and remounted for easy cleaning.

5. Control terminals

Specially developed removable spring-loaded cage clamps add to reliability and facilitate easy commissioning and service.

6. Fieldbus option

See complete list of available fieldbus options on page 41.

7. I/O options

The general purpose I/O, relay and thermistor expands the flexibility of the drives.

8. Display option

The removable VLT® Local Control Panel LCP 102 or the VLT® Wireless Communication Panel LCP 103 provide highly intuitive user interfaces. Choose between 27 built-in languages (including Chinese) or have it customized with your own. Languages can be changed by the user.

Alternatively the drive can be commissioned via the built-in USB/RS485 connection or through fieldbus options with the VLT® Motion Control Tool MCT 10 PC tool.



9. 24 V supply

A 24 V supply keeps the VLT® drives logically “alive” in situations when the AC power supply is removed.

10. Mains switch

This switch interrupts the mains supply and has a free useable auxiliary contact.

Safety

Please see chapter “Integrate Safely”.



The VLT® Real-time Clock MCB 117 option provides accurate time control functions and time stamp of logging data.

High-power modularity – D, E and F enclosures

The high-power VLT® HVAC Drive modules are all built on a modular platform allowing for highly customized drives which are mass produced, tested, and delivered from the factory.

Upgrades and further options dedicated to your industry are a matter of plug-and-play. Once you know one, you know them all.

1. Display options

Danfoss drives' renowned removable Local Control Panel (LCP) has an improved user interface. Choose between 27 built-in languages (including Chinese) or have it customized with your own. Languages can be changed by the user.

2. Hot pluggable LCP

The LCP can be plugged in or unplugged during operation. Settings are easily transferred via the control panel from one drive to another or from a PC with MCT 10 set-up software.

3. Integrated manual

The info button makes the printed manual virtually redundant. Users have been involved throughout development to ensure optimum overall functionality of the drive. The user group has significantly influenced the design and functionality of the LCP.

The Automatic Motor Adaptation (AMA), the Quick Set-Up menu and the large graphic display make commissioning and operation a breeze.

4. Fieldbus options

See complete list of available fieldbus options on page 41.

5. I/O options

The general purpose I/O, relay and thermistor expands the flexibility of the drives.

6. Control terminals

Specially developed removable spring-loaded cage clamps add to reliability and facilitate easy commissioning and service.

7. 24 V supply

A 24 V supply keeps the VLT® drives logically "alive" in situations when the AC power supply is removed.

8. RFI filter suitable for IT-grids

All high-power drives come standard with RFI filtering according to EN 61800-3 Cat. C3/EN 55011 class A2. A1/C2 RFI filters according to IEC 61000 and EN 61800 standards as integrated options.

9. Modular construction and ease of maintenance

All components are easily accessible from the front of the drive, allowing for ease of maintenance and side-by-side mounting of drives. The drives are constructed using a modular design that allows for the easy replacement of modular sub-assemblies.

10. Programmable options

A freely-programmable motion control option for user-specific control algorithms and programs allows the integration of PLC programs.

11. Conformally coated and ruggedized circuit boards

All high power drive circuit boards are conformal coated to withstand the salt mist test. Meets IEC 60721-3-3 Class 3C3. The conformal coating complies with ISA (International Society of Automation) standard S71.04 1985, class G3. Additionally, drives in D- and E-enclosures can be further ruggedized to withstand the higher vibration needs of certain applications.

12. Back-channel cooling

The unique design uses a back channel to pass cooling air over heat sinks. This design allows up to 90 % of the heat losses to be exhausted directly outside of the enclosure with minimal air passing through the electronics area. This reduces temperature rise and contamination of the electronic components for improved reliability and increased functional life.

As an option, the back-channel cooling duct can be supplied in stainless steel to provide a degree of corrosion resistance against conditions such as those found in salt-air environments near the ocean.

13. Enclosure

The drive meets relevant requirements for all possible installation conditions. Enclosure class chassis, IP20/chassis, IP21/UL Type 1, and IP54/UL Type 12. A kit is available to increase the enclosure class on enclosure size D drives to UL Type 3R.

14. DC-link reactor

The built-in DC-link reactor ensures low harmonic disturbance of the power supply in accordance with IEC-61000-3-12. The result is a more compact design with higher efficiencies than competitive systems with external mounted AC chokes.

15. Input mains option

Various input configurations are available, including fuses, mains disconnect switch, or RFI filter.

16. Front USB connector

gives IP54 access to the drive data with no impact on drive operation. Open the front door to access the internal USB port.



Efficiency is vital for high-power drives

Efficiency is essential in the design of the high-power VLT® drive series. Innovative design and exceptionally high-quality components have resulted in unsurpassed energy efficiency.

VLT® drives pass more than 98 % of the supplied electrical energy on to the motor. Only 2 % or less is left in the power electronics as heat to be removed.

Energy is saved and electronics last longer because they are not exposed to high temperatures within the enclosure.

Safety

Please see chapter "Integrate Safely".

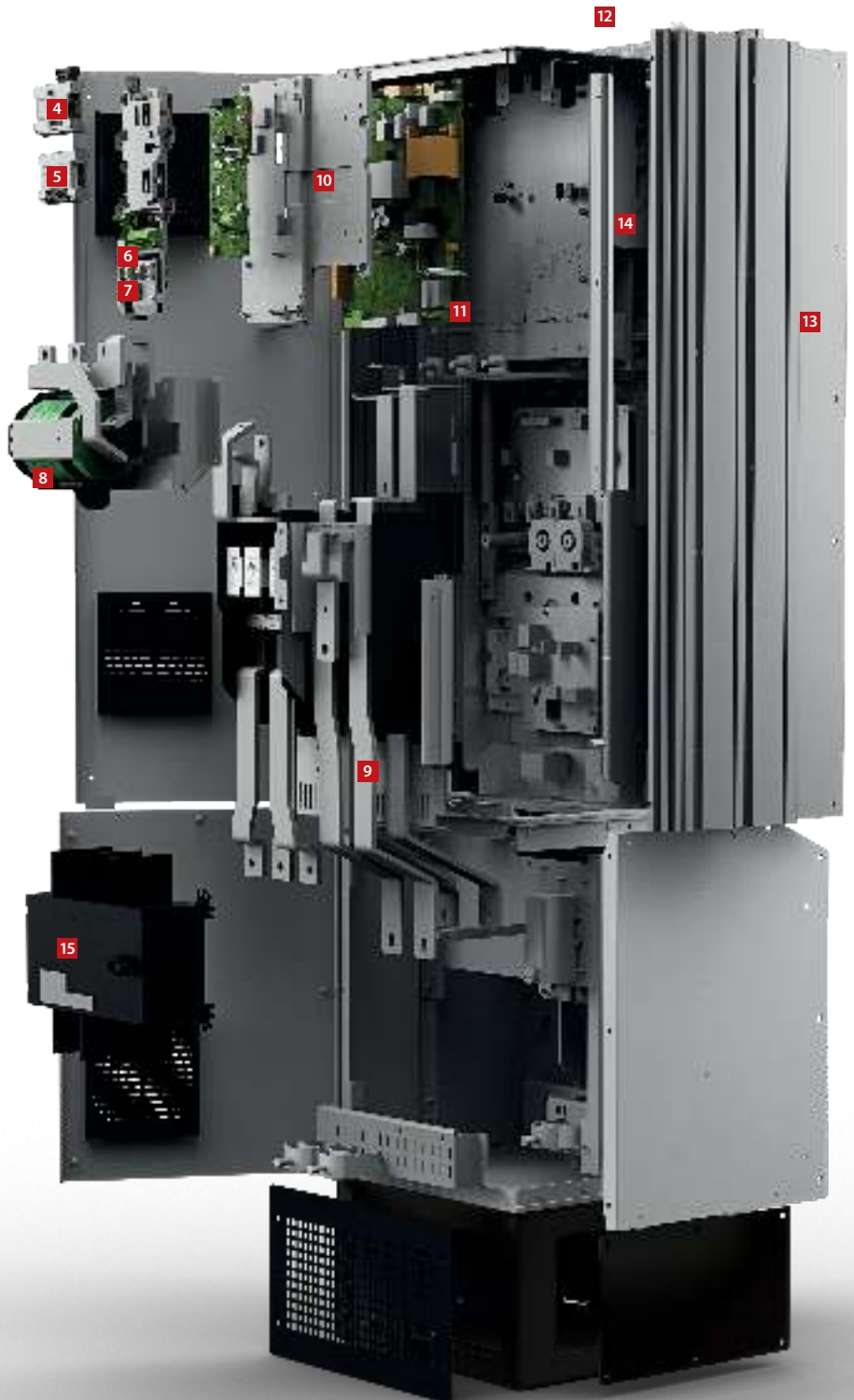

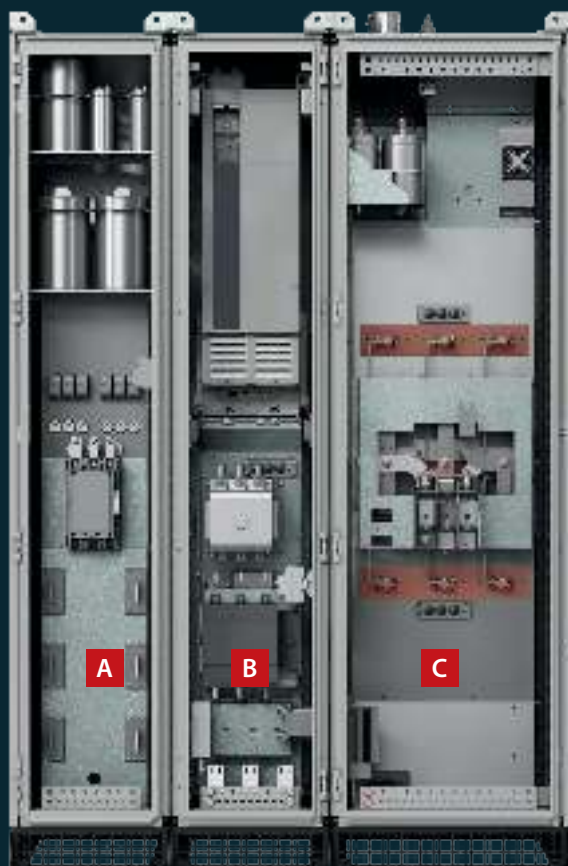

- A** Input filter cabinet
- B** Drive cabinet
- C** Output filter cabinet

Extended functionality for **high-performance operation – Enclosed Drives**

The high-power VLT® HVAC Enclosed Drives have been designed to meet the most demanding requirements for flexibility, robustness, compactness and ease of service. Each enclosed drive is precisely configured in flexible mass production, then individually tested and delivered from the Danfoss factory.

1. Door-mounted control compartment

separate from the main power terminals ensures safe accessibility to control terminals, also during operation of the drive.

2. VLT® HVAC

high-power drive in enclosure size D or E, with selectable control options.

3. Back-channel cooling assembly for power options

ensures utilization of the drive's back-channel cooling concept in the cabinet and efficient cooling of the integrated selectable power options.

4. Mains contactor

is a selectable mains power option.

5. Mains switch disconnect

is a selectable mains power option.

6. Bottom entry establishment

ensures IP54/UL type 12 connections of the enclosed drive mains terminals to the power supply.

7. Mains reactor assembly

of the selectable passive harmonic filter ensures absolute minimum harmonics content of the mains currents: **THDi <5 %**.

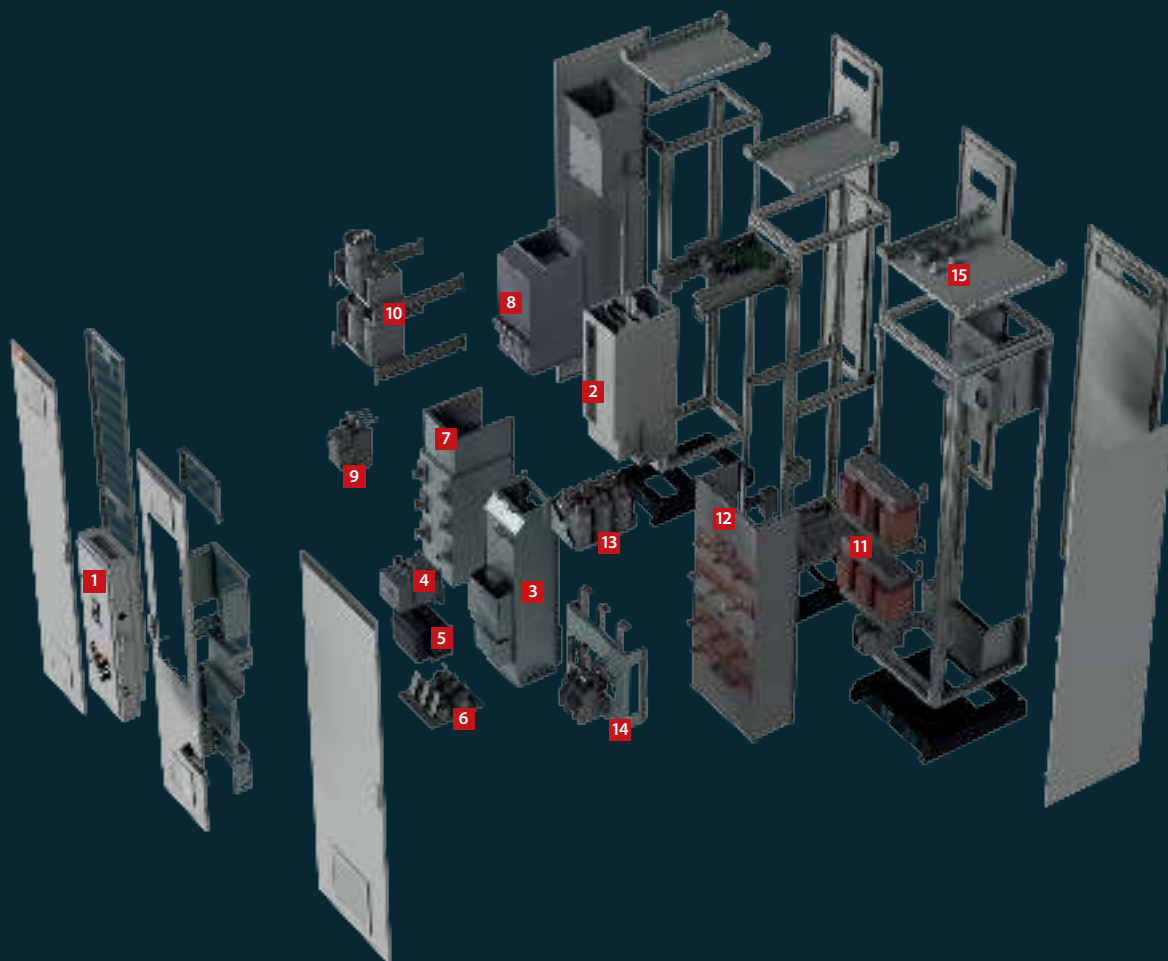

8. Passive filter magnetics
and the mains reactor of the passive filter are integrated into the back-channel cooling assembly of the cabinet.

9. Contactor
to control the passive harmonic filter of the drive.

10. Capacitor assembly
for the mains current passive harmonics filter.

11. Sine-wave filter magnetics
of the output filter, as a selectable power option.

12. Back-channel cooling assembly
for magnetics of the output sine-wave filter.

13. Capacitor assembly
for the sine-wave filter.

14. Motor connection terminals
are located in the sine-wave filter cabinet.

15. Top exit establishment
ensures IP54/UL type 12 connections of motor cables from the top.



Harmonic mitigation

– invest less and save more

The Danfoss solution for harmonic mitigation is a simple space and cost-saving design that increases system efficiency, to provide long-term energy savings and trouble-free operation.

Meet new standards

Efficient harmonic mitigation protects electronics and increases system efficiency. The prescribed standard for harmonics mitigation is specified as limits for the harmonic voltage distortion and current waveforms that may exist in the system to minimize interference between electrical equipment. The Danfoss harmonic mitigation solution is developed to meet the standards specified in the IEEE-519 2014 Guide.

Minimize costs using advanced active filters

Danfoss offers solutions for harmonics mitigation based on active front end, passive filter and advanced active filter (AAF) technology. Most applications will benefit from our central solution using AAF, minimizing cost and energy consumption to achieve the ambition of excellence in harmonic mitigation.

Certified solutions to control harmonics

- Advanced active filters
- Advanced harmonic filters
- Low harmonic drives
- 12-pulse drives
- Active front end drives

Low harmonic drives

The VLT® low harmonic drives continuously regulate the network and load conditions without affecting the connected motor. The drives combine the well-known performance and reliability of standard VLT® drives with an Advanced Active Filter. The result is a powerful, motor-friendly solution that provides the highest possible harmonic mitigation with total harmonic current distortion (THDi) of maximum 5 %.

Current and Distortion Spectrum at Full Load

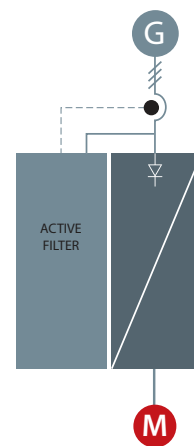
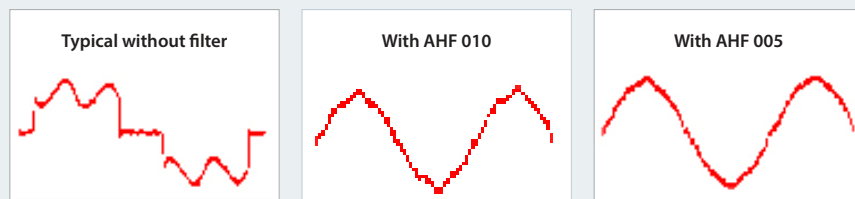

Advanced active filters

Advanced active filters identify harmonic distortion from non-linear loads and inject counter-phase harmonic and reactive currents into the AC line to cancel out the distortion. The result is distortion levels of no more than 5 % THDi. The optimal sinusoidal waveform of the AC power is restored and the power factor of the system is re-established at 1.

Advanced active filters follow the same design principles as all our other drives. The modular platform provides high energy efficiency, user-friendly operation, efficient cooling and high enclosure ratings.

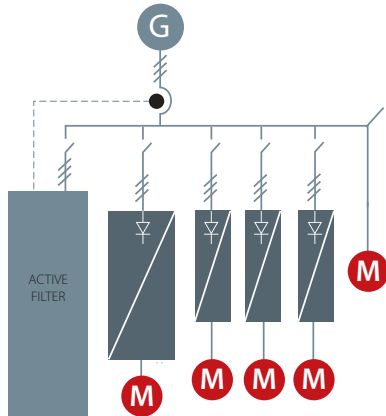

12-pulse drives

A robust and cost-effective harmonic solution for the higher power range, the Danfoss 12-pulse drive variants offer reduced harmonics for demanding industry applications above 250 kW.

VLT® 12-pulse drives are high efficiency AC drives which are built with the same modular design as the popular 6-pulse drives. The 12-pulse variant is available with similar drive options and accessories and can be configured according to your specific needs.

The VLT® 12-pulse drives provide harmonic reduction without adding capacitive or inductive components which often require network analysis to avoid potential system resonance problems.

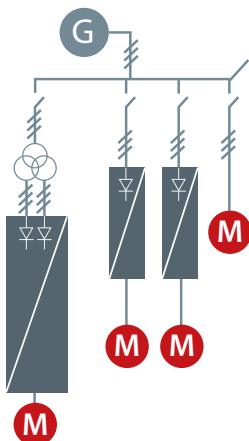

Advanced harmonic filters

The Danfoss harmonic filters are specially designed to be connected in front of a VLT® drive, and ensure that the harmonic current distortion generated back to the mains is reduced to a minimum.

Easy commissioning saves installation costs, and due to the maintenance-free design, running expenses for the units are eliminated.

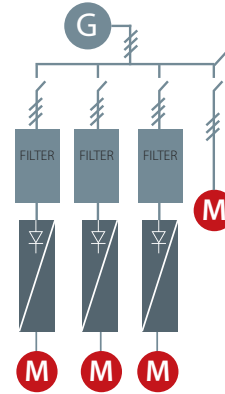

Active front-end drives

An AFE system is a regenerative power converter located at the front end of a common DC bus drive line-up, and is suitable in applications where:

- Regenerative power generation is the goal
- Low harmonics are required
- The frequency inverter load is up to 100 % of the total generator capacity

An active front-end (AFE) system comprises two identical inverters with a common DC bus. There is one motor inverter and one supply inverter. The supply inverter works together with a tuned sinus filter, and the current distortion (THDi) at the supply is about 3-4 %.

When an AFE system is installed, then the motor voltage can be increased above that of the network, because adjustment of the DC link voltage is enabled. Any excessive energy can be returned to the network as clean (active) power, rather than reactive power, which only produces heat.





MyDrive® Suite ensures your digital tools are only one click away

MyDrive® Suite brings all your tools together to support you during engineering, operation and service. What is MyDrive® Suite? It's a tool providing a single point of access for the other digital tools supporting you during engineering, operation and service, thereby covering the whole life cycle of the drive.

Based on your needs, the tools are accessible via different platforms. They can be integrated into your system and business processes to enable a world-class end-to-end experience with full flexibility. Your data is synchronized between the tools, and by sharing the same data backend, information is always correct and up to date.

Our suite of software tools is designed to ensure you easy operation and the highest level of customization of your

AC drives. Whether you're a beginner or a pro, you have everything you need to go from selecting to programmability of a drive.

Try MyDrive® Suite today:
<https://suite.mydrive.danfoss.com/content/tools>

Easy to use

- One tool suite
- One common look and feel
- Single login to all tools
- Seamless usage across devices and touchpoints
- Platform enables coherent workflows
- Data synchronization between tools. There is no need to enter information twice, which means your information is always correct and up to date
- Search and smart filtering
- Tutorials and documentation

Keeps your data safe

- Data security through user levels and authentication
- End-to-end secure communication

Fits your needs

- Data integration into your tools and systems
- APIs and open interfaces facilitate third-party applications or branded versions
- The tools are available as web app, desktop application, dedicated tablet and smartphone app, all with offline functionality. No internet connection is required once the tool is installed to your device

Convenient and fast – Digital tools empower you

Need help to design your application, or select, set up, and maintain your drive? Danfoss provides a palette of digital tools to give you the information you need, at your fingertips. No matter which stage of the project you are at.

Select and configure your drives

- Select the right AC drive based on motor and load characteristics
- Find general product, segment and application information of VLT® and VACON® drives

Available tools:

- **MyDrive® Select**
Select and dimension your drive based on calculated motor load currents as well as current, temperature and ambient limitations. MyDrive® Select matches your business needs with Danfoss Drives products.

- **MyDrive® Portfolio**

This smart device app gives you a full overview of all Danfoss Drives products and their documentation.

Set up and service your drives

- Set up your drives to operate according to your requirements
- Monitor drive performance throughout the entire lifecycle of your drive

Available tools:

- **MyDrive® Connect**
Connect to one or more drives over a secure Wi-Fi connection. Provides a simple and intuitive interface for easy commissioning.

- **VLT® Motion Control Tool MCT 10**

Configure the drive from a PC. With functionality for drive firmware update and configuration of functional safety using the safe plugin.

Customize your drives

- Optimize performance & behavior
- Emphasize your brand by defining own parameter names
- Get PLC-based functionality based on IEC61131-3
- Enable license-based functions

Available tools:

- **VLT® Software Customizer**
Emphasize your brand by modifying the splash screen and create your own smart start wizard.

Validate performance of your drives

- Analyze the performance of your drives in relation to harmonics content
- Calculate the energy savings to be achieved when using drives
- Validate compliance to norms and standards

Available tools:

- **MyDrive® ecoSmart™**
Now it's easy to determine IE and IES classes according to IEC/EN 61800-9, for VLT® and VACON® drives alone and in combination with a motor. MyDrive® ecoSmart™ uses nameplate data to perform the efficiency calculations, and produces a pdf report for documentation.

- **MyDrive® Harmonics**

Estimate the benefits of adding harmonic mitigation solutions from the Danfoss product portfolio and calculate predicted system harmonic distortion. This tool provides a quick indication of installation compliance with the most recognized harmonic norms, and mitigation recommendations.

- **VLT® EnergyBox**

This advanced energy calculation tool captures actual energy data from the drives, to document It also monitors energy consumption and overall system efficiency.



Online tool:
ecosmart.danfoss.com
App: MyDrive® ecoSmart™



DrivePro® Life Cycle services

Delivering a customized service experience!

We understand that every application is different. Having the ability to build a customized service package to suit your specific needs is essential.

DrivePro® Life Cycle Services is a collection of tailor-made products designed around you. Each one engineered to support your business through the different stages of your AC drive's life cycle.

From optimized spare-part packages to condition-monitoring solutions, our products can be customized to help you achieve your business goals.

With the help of these products, we add value to your application by ensuring you get the most out of your AC drive.

When you deal with us, we also offer you access to training, as well as the application knowledge to help you in planning and preparation. Our experts are at your service.

drivepro.danfoss.com

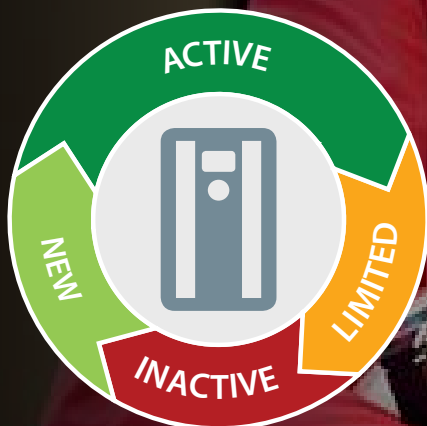

You're covered

with DrivePro® Life Cycle service products



DrivePro® Site Assessment **Optimize planning based on a site-wide survey**

DrivePro® Site Assessment provides you with a detailed survey of all your AC drives, delivering a clear picture of current and future maintenance needs. In collaboration with you we inspect and assess your on-site drive assets, analyze and evaluate the data, report risk assessment and recommend services, then collaborate with you to tailor a service solution to your maintenance strategy. Our recommendations empower you to plan maintenance, retrofits, and future upgrades to optimize profitable production at your site.



DrivePro® Preventive Maintenance **Take preventive action**

You receive a maintenance plan and budget, based on an audit of the installation. Then our experts perform the maintenance tasks for you, according to the defined plan.



DrivePro® Upgrade **Maximize your AC drive investment**

Use an expert to replace parts or software in a running unit, so your drive is always up-to-date. You receive an on-site evaluation, an upgrade plan and recommendations for future improvements.



DrivePro® Start-up **Fine-tune your drive for optimal performance today**

Save on installation and commissioning time and cost. Get help from professional drives experts during start-up, to optimize drives safety, availability and performance.



DrivePro® Remote Monitoring **Fast resolution of issues**

DrivePro® Remote Monitoring offers you a system that provides online information available for monitoring in real time. It collects all the relevant data and analyzes it so that you can resolve issues before they affect your processes.



DrivePro® Extended Warranty **Long-term peace of mind**

Get the longest coverage available in the industry, for peace of mind, a strong business case and a stable, reliable budget. You know the annual cost of maintaining your drives, up to six years in advance.



DrivePro® Remote Expert Support **You can rely on us every step of the way**

DrivePro® Remote Expert Support offers speedy resolution of on-site issues thanks to timely access to accurate information. With the secure connection, our drives experts analyze issues remotely reducing the time and cost involved in unnecessary service visits.



DrivePro® Spare Parts **Plan ahead with your spare part package**

In critical situations, you want no delays. With DrivePro® Spare Parts you always have the right parts on hand, on time. Keep your drives running at top efficiency, and optimize system performance.



DrivePro® Retrofit **Minimize the impact and maximize the benefit**

Manage the end of product lifecycle efficiently, with professional help to replace your legacy drives. The DrivePro® Retrofit service ensures optimal uptime and productivity during the smooth replacement process.



DrivePro® Exchange **The fast, most cost-efficient alternative to repair**

You obtain the fastest, most cost-efficient alternative to repair, when time is critical. You increase uptime, thanks to quick and correct replacement of the drive.to-date. You receive an on-site evaluation, an upgrade plan and recommendations for future improvements.

To learn which products are available in your region, please reach out to your local Danfoss Drives sales office or visit our website <http://drives.danfoss.com/danfoss-drives/local-contacts/>

Connection example

The numbers represent the terminals on the drive

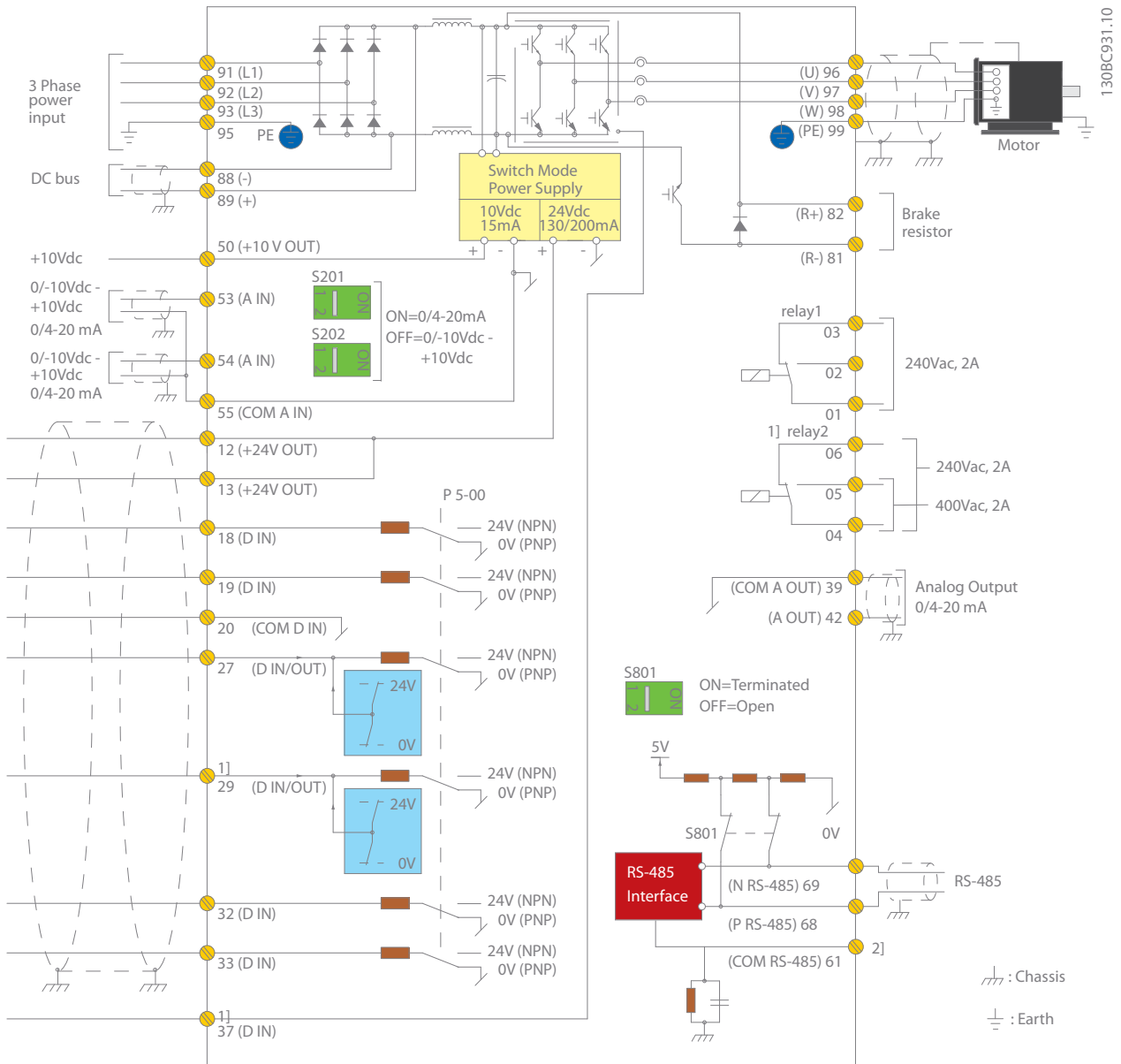

A=Analog, D=Digital

1] Terminal 37 (optional) is used for Safe Torque Off. For Safe Torque Off installation instructions, refer to the *Safe Torque Off Operating Instructions for Danfoss VLT® Frequency Converters*. Terminal 37 is not included in FC 301 (except enclosure type A1). Relay 2 and terminal 29 have no function in FC 301.
2] Do not connect cable screen.

This diagram shows a typical installation of the VLT® HVAC Drive. Power is connected to the terminals 91 (L1), 92 (L2) and 93 (L3) and the motor is connected to 96 (U), 97 (V) and 98 (W).

Terminals 88 and 89 are used for load sharing between drives. Analogue inputs can be connected to the 53 (V or mA), and for 54 (V or mA) terminals.

These inputs can be set up as either reference, feedback or thermistor inputs.

There are 6 digital inputs to be connected to terminals 18, 19, 27, 29, 32, and 33. Two digital input/output terminals (27 and 29) can be set up as digital outputs to show an actual status or warning or can be used as pulse reference signal. The terminal 42 analogue output can show process values such as 0 - I_{max}.

On the 68 (P+) and 69 (N-) terminals' RS 485 interface, the drive can be controlled and monitored via serial communication.

Technical data

Basic unit without extensions

Main supply (L1, L2, L3)	
Supply voltage	200-240 V AC 380-480 V AC 525-600 V AC 525-690 V AC
Supply frequency	50/60 Hz
Displacement power factor (cos φ) near unity	> 0.98
Switching on input supply L1, L2, L3	1-2 times/min.
Output data (T1, T2, T3)	
Output voltage	0-100 % of supply voltage
Output frequency	0-590 Hz
Switching on output	2-16kHz
Ramp times	0.01-3600 s
Digital inputs	
Programmable digital inputs	6*
Changeable to digital output	2 (terminal 27, 29)
Logic	PNP or NPN
Voltage level	0-24 V DC
Maximum voltage on input	28 V DC
Input resistance, Ri	Approx. 4 kΩ
Scan interval	5 ms

* Two of the inputs can be used as digital outputs

Analog inputs	
Analog inputs	2
Modes	Voltage or current
Voltage level	0 to +10 V (scaleable)
Current level	0/4 to 20 mA (scaleable)
Accuracy of analog inputs	Max. error: 0.5 % of full scale
Pulse inputs	
Programmable pulse inputs	2*
Voltage level	0-24 V DC (PNP positive logic)
Pulse input accuracy (0.1-1 kHz)	Max. error: 0.1 % of full scale

* Two of the digital inputs can be used for pulse inputs.

Digital outputs	
Programmable digital/pulse outputs	2
Voltage level at digital/frequency output	0-24 V DC
Max. output current (sink or source)	40 mA
Maximum output frequency	0-32 kHz
Accuracy on frequency output	Max. error: 0.1 % of full scale
Analog outputs	
Programmable analog outputs	1
Current range at analog output	0/4-20 mA
Max. load to common at analog output (clamp 30)	500 Ω
Accuracy on analog output	Max. error: 0.5 % of full scale

Control card	
USB interface	1.1 (Full Speed)
USB plug	Type "B"
RS485 interface	Up to 115 kBAud
Max. load (10 V)	15 mA
Max. load (24 V)	200 mA

Relay outputs	
Programmable relay outputs	2
Max. terminal load (AC) on 1-3 (NC), 1-2 (NO), 4-6 (NC) power card	240 V AC, 2 A
Max. terminal load (AC -1) on 4-5 (NO) power card	400 V AC, 2 A
Min. terminal load on 1-3 (NC), 1-2 (NO), 4-6 (NC), 4-5 (NO) power card	24 V DC 10 mA, 24 V AC 20 mA

Surroundings/external	
Ingress protection class	IP: 00/20/21/54/55/66 UL Type: Chassis/1/12/3R/4X
Vibration test	0.7 g
Max. relative humidity	5-95 % (IEC 721-3-3); Class 3K3 (non-condensing) during operation
Ambient temperature	-10 to +50C without derating (IE2 motor & A,B & C frames)
Galvanic isolation of all	I/O supplies according to PELV
Aggressive environment	Designed for 3C3 (IEC 60721-3-3)
Operation altitude	<p>PELV Insulation: The drive can operate at altitude up to 2000 m (6560 ft) without any consideration for additional insulation to fulfill ISO61800-5-1.</p> <p>Cooling: The drive operate at altitudes up to 1000 m (3280 ft) without derating, and with derating up to 3500 m (11482 ft) for the enclosure sizes A-B-C, and with derating up to 3000 m (9842 ft) for enclosure sizes D-E-F.</p>

Ambient temperature	
All drives in the series operate at temperatures from -10 °C to 45 °C without derating. Under special conditions the operating temperature range extends to -25 °C to +55 °C. For more information please refer to the Design Guide.	

Fieldbus communication	
Standard built-in: FC Protocol N2 Metasys FLN Apogee Modbus RTU BACnet (embedded)	Optional: VLT® PROFIBUS DP V1 MCA 101 VLT® DeviceNet MCA 104 VLT® LonWorks MCA 108 VLT® BACnet MCA 109 VLT® PROFINET MCA 120 VLT® EtherNet/IP MCA 121 VLT® Modbus TCP MCA 122 VLT® BACnet/IP MCA 125

Protection mode for longest possible up-time	
Electronic motor thermal protection against overload	
Protection against overtemperature	
The AC drive is protected against short circuits on motor terminals U, V, W	
The AC drive is protected against ground faults on motor terminals U, V, W	
Protection against mains phase loss	

Agency approvals



Enclosure overview **A, B** and **C**

3 phases

VLT® HVAC Drive FC 102			T2 200-240 V				T4 380-480 V				T6 525-600 V				T7 525-690 V		
Type code	kW		IP20	IP21	IP55	IP66	IP20	IP21	IP55	IP66	IP20	IP21	IP55	IP66	IP20	IP21	IP55
	HO	NO															
P1K1	1.1																
P1K5	1.5		A2	A2	A4/A5	A4/A5	A2	A2	A4/A5	A4/A5	A3	A3	A5	A5	A3		
P2K2	2.2																
P3K0	3.0																
P3K7	3.7		A3	A3	A5	A5											
P4K0	4.0						A2	A2	A4/A5	A4/A5							
P5K5	3.7	5.5					A2	A2	A4/A5	A4/A5	A3	A3	A5	A5	A3		
P7K5	5.5	7.5	B3	B1	B1	B1	A3	A3	A5	A5	A3	A3	A5	A5	A3		
P11K	7.5	11															
P15K	11	15	B4	B2	B2	B2	B3	B1	B1	B1	B3	B1	B1	B1			
P18K	15	18.5															
P22K	18.5	22															
P30K	22	30	C3	C1	C1	C1	B4	B2	B2	B2	B4	B2	B2	B2	B4	B2	B2
P37K	30	37															
P45K	37	45	C4	C2	C2	C2											
P55K	45	55															
P75K	55	75															
P90K	75	90					C3	C1	C1	C1	C3	C1	C1	C1	C3	C2	C2
							C4	C2	C2	C2	C4	C2	C2	C2			

1 phase

VLT® AQUA Drive		S2 200-240 V				S4 380-480 V		
FC 200	kW	IP20	IP21	IP55	IP66	IP21	IP55	IP66
P1K1	1.1	A3		A5	A5			
P1K5	1.5							
P2K2	2.2							
P3K0	3.0		B1	B1	B1			
P3K7	3.7							
P5K5	5.5							
P7K5	7.5		B2	B2	B2	B1	B1	B1
P11K	11					B2	B2	B2
P15K	15		C1	C1	C1			
P18K	18.5					C1	C1	C1
P22K	22		C2	C2	C2			
P37K	37					C2	C2	C2

- IP20/Chassis
- IP21/Type 1
- IP21 with upgrade kit
– available in North America only
- IP55/Type 12
- IP66/NEMA 4X



Electrical data – A, B, and C enclosures

[T2] 3 x 200-240 V AC

Type code	Normal overload (110 % 1 min/10 min)						Enclosure size			
	Output current (3 x 200-240 V)		Typical shaft output power		Continuous input current	Estimated power loss	Protection rating [IEC/UL]			
	Con. I _N	Inter. I _{MAX} (60 s)	kW @ 208 V	Hp @ 230 V	[A]	[W]	IP20	IP21	IP55	IP66
FC-102	Con. I _N	Inter. I _{MAX} (60 s)	kW @ 208 V	Hp @ 230 V	[A]	[W]	Chassis	Type 1	Type 12	Type 4X
P1K1	6.6	7.3	1.1	1.5	5.9	63	A2	A2*	A4/A5**	A4/A5**
P1K5	7.5	8.3	1.5	2	6.8	82	A2	A2*	A4/A5**	A4/A5**
P2K2	10.6	11.7	2.2	3	9.5	116	A2	A2*	A4/A5**	A4/A5**
P3K0	12.5	13.8	3	4	11.3	155	A3	A3*	A5	A5
P3K7	16.7	18.4	3.7	5	15.0	185	A3	A3*	A5	A5
P5K5	24.2	26.6	5.5	7.5	22.0	310	B3	B1	B1	B1
P7K5	30.8	33.9	7.5	10	28.0	310	B3	B1	B1	B1
P11K	46.2	50.8	11	15	42.0	514	B3	B1	B1	B1
P15K	59.4	65.3	15	20	54.0	602	B4	B2	B2	B2
P18K	74.8	82.3	18.5	25	68.0	737	B4	C1	C1	C1
P22K	88	96.8	22	30	80.0	845	C3	C1	C1	C1
P30K	115	127	30	40	104.0	1140	C3	C1	C1	C1
P37K	143	157	37	50	130.0	1353	C4	C2	C2	C2
P45K	170	187	45	60	154.0	1636	C4	C2	C2	C2

* Requires an IP21/Type 1 kit. Available in North America only.

** A4 does not accept any C options

[T4] 3 x 380-480 V AC

Type code	Normal overload (110 % 1 min/10 min)							Enclosure size				
	Output current				Typical shaft output power		Continuous input current	Estimated power loss	Protection rating [IEC/UL]			
	(3 x 380-440 V)		(3 x 441-480 V)		kW @ 400 V	Hp @ 460 V	[A] @ 400 V	[W]	IP20	IP21	IP55	IP66
FC-102	Con. I _N	Inter. I _{MAX} (60 s)	Con. I _N	Inter. I _{MAX} (60 s)	kW @ 400 V	Hp @ 460 V	[A] @ 400 V	[W]	Chassis	Type 1	Type 12	Type 4X
P1K1	3	3.3	2.7	3	1.1	1.5	2.7	58	A2	A2	A4/A5	A4/A5
P1K5	4.1	4.5	3.4	3.7	1.5	2	3.7	62	A2	A2	A4/A5	A4/A5
P2K2	5.6	6.2	4.8	5.3	2.2	3	5.0	88	A2	A2	A4/A5	A4/A5
P3K0	7.2	7.9	6.3	6.9	3	4	6.5	116	A2	A2	A4/A5	A4/A5
P4K0	10	11	8.2	9	4	5	9.0	124	A2	A2	A4/A5	A4/A5
P5K5	13	14.3	11	12.1	5.5	7.5	11.7	187	A3	A3	A5	A5
P7K5	16	17.6	14.5	16	7.5	10	14.4	225	A3	A3	A5	A5
P11K	24	26.4	21	23.1	11	15	22.0	392	B3	B1	B1	B1
P15K	32	35.2	27	29.7	15	20	29.0	392	B3	B1	B1	B1
P18K	37.5	41.3	34	37.4	18.5	25	34.0	465	B3	B1	B1	B1
P22K	44	48.4	40	44	22	30	40.0	525	B4	B2	B2	B2
P30K	61	67.1	52	61.6	30	40	55.0	739	B4	B2	B2	B2
P37K	73	80.3	65	71.5	37	50	66.0	698	B4	C1	C1	C1
P45K	90	99	80	88	45	60	82.0	843	C3	C1	C1	C1
P55K	106	117	105	116	55	75	96.0	1083	C3	C1	C1	C1
P75K	147	162	130	143	75	100	133	1384	C4	C2	C2	C2
P90K	177	195	160	176	90	125	161	1474	C4	C2	C2	C2

[T6] 3 x 525-600 V AC

Normal overload (110 % 1 min/10 min)							Enclosure size			
Type code	Output current (3 x 525-600 V)		Typical shaft output power		Continuous input current	Estimated power loss	Protection rating [IEC/UL]			
	Con. I _N	Inter. I _{MAX} (60 s)	kW @ 575 V	Hp @ 575 V			IP20	IP21	IP55	IP66
FC-102	Con. I _N	Inter. I _{MAX} (60 s)	kW @ 575 V	Hp @ 575 V	[A]	[W]	Chassis	Type 1	Type 12	Type 4X
P1K1	2.4	2.6	1.1	1.5	2.4	50	A3	A3	A5	A5
P1K5	2.7	3	1.5	2	2.7	65	A3	A3	A5	A5
P2K2	3.9	4.3	2.2	3	4.1	92	A3	A3	A5	A5
P3K0	4.9	5.4	3	4	5.2	122	A3	A3	A5	A5
P4K0	6.1	6.7	4	5	5.8	145	A3	A3	A5	A5
P5K5	9	9.9	5.5	7.5	8.6	195	A3	A3	A5	A5
P7K5	11	12.1	7.5	10	10.4	261	A3	A3	A5	A5
P11K	18	20	11	15	17.2	300	B3	B1	B1	B1
P15K	22	24	15	20	20.9	300	B3	B1	B1	B1
P18K	27	30	18.5	25	25.4	370	B3	B1	B1	B1
P22K	34	37	22	30	32.7	440	B4	B2	B2	B2
P30K	41	45	30	40	39.0	600	B4	B2	B2	B2
P37K	52	57	37	50	49.0	740	B4	C1	C1	C1
P45K	62	68	45	60	59.0	900	C3	C1	C1	C1
P55K	83	91	55	75	78.9	1100	C3	C1	C1	C1
P75K	100	110	75	100	95.3	1500	C4	C2	C2	C2
P90K	131	144	90	125	124.3	1800	C4	C2	C2	C2

[T7] 3 x 525-690 V AC

Normal overload (110 % 1 min/10 min)								Enclosure size			
Type code	Output current				Typical shaft output power		Continuous input current	Estimated power loss	Protection rating [IEC/UL]		
	(3 x 525-550 V)		(3 x 551-690 V)		kW @ 690 V	Hp @ 575 V			IP20	IP21	IP55
FC-102	Con. I _N	Inter. I _{MAX} (60 s)	Con. I _N	Inter. I _{MAX} (60 s)	kW @ 690 V	Hp @ 575 V	[A] @ 690 V	[W]	Chassis	Type 1	Type 12
P1K1	2.1	2.3	1.6	1.8	1.1	1.5	1.4	44	A3	-	-
P1K5	2.7	3	2.2	2.4	1.5	2	2.0	60	A3	-	-
P2K2	3.9	4.3	3.2	3.5	2.2	3	2.9	88	A3	-	-
P3K0	4.9	5.4	4.5	5	3	4	4.0	120	A3	-	-
P4K0	6.1	6.7	5.5	6.1	4	5	4.9	160	A3	-	-
P5K5	9	9.9	7.5	8.3	5.5	7.5	6.7	220	A3	-	-
P7K5	11	12.1	10	11	7.5	10	9.0	300	A3	-	-
P11K	14	15.4	13	14.3	11	15	15.0	220	B4	B2	B2
P15K	19	20.9	18	19.8	15	20	19.5	220	B4	B2	B2
P18K	23	25.3	22	24.2	18.5	25	24.0	300	B4	B2	B2
P22K	28	30.8	27	29.7	22	30	29.0	370	B4	B2	B2
P30K	36	39.6	34	37.4	30	40	36.0	440	B4	B2	B2
P37K	43	47.3	41	45.1	37	50	49.0	740	B4	C2	C2
P45K	54	59.4	52	57.2	45	60	59.0	900	C3	C2	C2
P55K	65	71.5	62	68.2	55	75	71.0	1100	C3	C2	C2
P75K	87	95.7	83	91.3	75	100	87.0	1500	-	C2	C2
P90K	105	115.5	100	110	90	125	99.0	1800	-	C2	C2

Dimensions enclosure sizes A, B and C

Enclosure size		VLT® HVAC Drive													
		A2		A3		A4	A5	B1	B2	B3	B4	C1	C2	C3	C4
Protection rating [IEC/UL]		IP20 Chassis	IP21 Type 1	IP20 Chassis	IP21 Type 1	IP55/Type 12 IP66/Type 4X	IP21/Type 1 IP55/Type 12 IP66/Type 4X	IP20/Chassis	IP20/Chassis	IP20/Chassis	IP21/Type 1 IP55/Type 12 IP66/Type 4X	IP20/Chassis	IP20/Chassis	IP20/Chassis	
[mm]	Height	268	375	268	375	390	420	480	650	399	520	680	770	550	660
	Height with decoupling plate	374	-	374	-	-	-	-	-	420	595	-	-	630	800
	Width	90	90	130	130	200	242	242	242	165	230	308	370	308	370
	Width with one C option	130	130	170	170	-	242	242	242	205	230	308	370	308	370
	Depth	205	207	205	207	175	200	260	260	249	242	310	335	333	333
	Depth with A, B option	220	222	220	222	175	200	260	260	262	242	310	335	333	333
	Depth with mains disconnect	-	-	-	-	206	224	289	290	-	-	344	378	-	-
[kg]	Weight	4.9	5.3	6	7	9.7	14.2	23	27	12	23.5	45	64	35	50
[in]	Height	10.6	14.8	10.6	14.8	15.4	16.6	18.9	25.6	15.8	20.5	26.8	30.4	21.7	26
	Height with decoupling plate	14.8	-	14.8	-	-	-	-	-	16.6	23.5	-	-	24.8	31.5
	Width	3.6	3.6	5.2	5.2	7.9	9.6	9.6	9.6	6.5	9.1	12.2	14.6	12.2	14.6
	Width with one C option	5.2	5.2	6.7	6.7	-	9.6	9.6	9.6	8.1	9.1	12.2	14.6	12.2	14.6
	Depth	8.1	18.2	8.1	8.2	6.9	7.9	10.3	10.3	9.8	9.6	12.3	13.2	13	13
	Depth with mains disconnect	-	-	-	-	8.2	8.9	11.4	11.5	-	-	13.6	14.9	-	-
	Depth with A, B option	8.7	8.8	8.7	8.8	6.9	7.9	10.3	10.3	10.4	9.6	12.3	13.2	13	13
[lb]	Weight	10.8	11.7	14.6	15.5	21.5	31.5	50.7	59.6	26.5	52	99.3	143.3	77.2	110.2

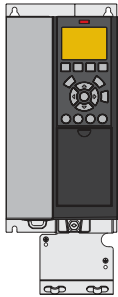

A3 IP20/Chassis with decoupling plate

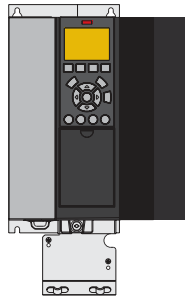

A3 IP20 with option C

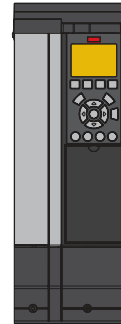

A3 with IP21/Type 12 NEMA 1 Kit

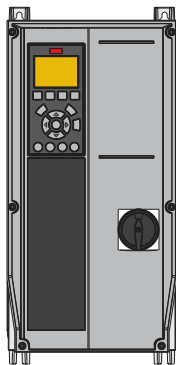

A4 IP55 with mains disconnect

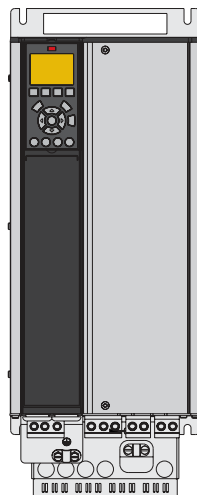

B4 IP20

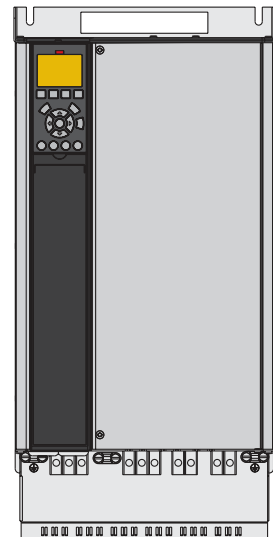

C3 IP20

Enclosure overview D, E and F

6-pulse

VLT® HVAC Drive FC 102		T2 200-240 V			T4 380-480 V			T7 525-690 V		
Type code	kW	IP20	IP21	IP54	IP20	IP21	IP54	IP20	IP21	IP54
	NO									
N55K	55	D3h	D1h	D1h						
N75K	75									
N90K	90	D4h	D2h	D2h						
N110	110									
N132	132				D3h	D1h D5h D6h	D1h D5h D6h	D3h	D1h D5h D6h	D1h D5h D6h
N160	160									
N200	200									
N250	250				D4h	D2h D7h D8h	D2h D7h D8h	D4h	D2h D7h D8h	D2h D7h D8h
N315	315									
N355	355									
N400	400				E3h	E1h	E1h	D4h	D2h D7h D8h	D2h D7h D8h
N450	450									
N500	500									
N560	560				E4h	E2h	E2h	E3h	E1h	E1h
N630	630									
N710	710									
N800	800							E4h	E2h	E2h
P500	500									
P560	560									
P630	630					F1/F3	F1/F3			
P710	710									
P800	800					F2/F4	F2/F4	F1/F3	F1/F3	
P900	900									
P1M0	1000					F2/F4	F2/F4			
P1M2	1200							F2/F4	F2/F4	
P1M4	1400									

12-pulse

VLT® HVAC Drive FC 102		T4 380-480 V				T7 525-690 V			
Type code	kW	IP21	IP21 + options	IP54	IP54 + options	IP21	IP21 + options	IP54	IP54 + options
	NO								
P315	315								
P355	355	F8	F9	F8	F9				
P400	400								
P450	450								
P500	500								
P560	560	F10	F11	F10	F11	F8	F9	F8	F9
P630	630								
P710	710								
P800	800	F12	F13	F12	F13	F10	F11	F10	F12
P900	900								
P1M0	1000	F12	F13	F12	F13				
P1M2	1200					F12	F13	F12	F13
P1M4	1400								

- P20/Chassis
- IP21/Type 1
- IP54/Type 12



Electrical data – D, E and F enclosures

[T2] 3 x 200-240 V AC

Normal overload (110 % 1 min/10 min)							Enclosure size		
Type code	Output current (3 x 200-240 V)		Typical shaft output power		Continuous input current [A]	Estimated power loss [W]	Protection rating [IEC/UL]		
	Con. I _N	Inter. I _{MAX} (60 s)	kW at 208 V	HP at 230 V			IP20	IP21	IP54
FC-102	Con. I _N	Inter. I _{MAX} (60 s)	kW at 208 V	HP at 230 V	[A]	[W]	Chassis	Type 1	Type 12
N55K	190	209	55	75	183	1505	D3h	D1h	
N75K	240	264	75	100	231	2398	D3h	D1h	
N90K	302	332	90	120	291	2623	D4h	D2h	
N110	361	397	110	150	348	3284	D4h	D2h	
N150	443	487	150	200	427	4117	D4h	D2h	
N160	535	589	160	215	516	5209	D4h	D2h	

[T4] 3 x 380-480 V AC

Normal overload (110 % 1 min/10 min)								Enclosure size			
Type code	Output current				Typical shaft output power		Continuous input current [A] @ 400 V	Estimated power loss [W]	Protection rating [IEC/UL]		
	(3 x 380-440 V)		(3 x 441-480 V)		kW @ 400 V	Hp @ 460 V			IP20	IP21	IP54
FC-102	Con. I _N	Inter. I _{MAX} (60 s)	Con. I _N	Inter. I _{MAX} (60 s)	kW @ 400 V	Hp @ 460 V	[A] @ 400 V	[W]	Chassis	Type 1	Type 12
N110	212	233	190	209	110	150	204	2559	D3h	D1h/D5h/D6h	
N132	260	286	240	264	132	200	251	2954	D3h	D1h/D5h/D6h	
N160	315	347	302	332	160	250	304	3770	D3h	D1h/D5h/D6h	
N200	395	435	361	397	200	300	381	4116	D4h	D2h/D7h/D8h	
N250	480	528	443	487	250	350	463	5137	D4h	D2h/D7h/D8h	
N315	588	647	535	588	315	450	567	6674	D4h	D2h/D7h/D8h	
N355	658	724	590	649	355	500	634	6928	E3h	E1h	E1h
N400	745	820	678	746	400	550	718	8036	E3h	E1h	E1h
N450	800	880	730	803	450	600	771	8783	E3h	E1h	E1h
N500	880	968	780	858	500	650	848	9473	E4h	E2h	E2h
N560	990	1089	890	979	560	750	954	11102	E4h	E2h	E2h
P500	880	968	780	858	500	650	848	10162	–	F1/F3	F1/F3
P560	990	1089	890	979	560	750	954	11822	–	F1/F3	F1/F3
P630	1120	1232	1050	1155	630	900	1079	12512	–	F1/F3	F1/F3
P710	1260	1386	1160	1276	710	1000	1214	14674	–	F1/F3	F1/F3
P800	1460	1606	1380	1518	800	1200	1407	17293	–	F2/F4	F2/F4
P1M0	1720	1892	1530	1683	1000	1350	1658	19278	–	F2/F4	F2/F4

[T7] 3 x 525-690 V AC

Type code	Normal overload (110 % 1 min/10 min)								Enclosure size		
	Output current				Typical shaft output power		Continuous input current	Estimated power loss	Protection rating [IEC/UL]		
	(3 x 525-550 V)		(3 x 551-690 V)						IP20	IP21	IP54
FC-102	Con. I _N	Inter. I _{MAX} (60 s)	Con. I _N	Inter. I _{MAX} (60 s)	kW @ 690 V	Hp @ 575 V	[A]	[W]	Chassis	Type 1	Type 12
N75K	90	99	86	95	75	75	83	1162	D3h	D1h/D5h/D6h	
N90K	113	124	108	119	90	100	104	1428	D3h	D1h/D5h/D6h	
N110	137	151	131	144	110	125	126	1740	D3h	D1h/D5h/D6h	
N132	162	178	155	171	132	150	149	2101	D3h	D1h/D5h/D6h	
N160	201	221	192	211	160	200	185	2649	D3h	D1h/D5h/D6h	
N200	253	278	242	266	200	250	233	3074	D4h	D2h/D7h/D8h	
N250	303	333	290	319	250	300	279	3723	D4h	D2h/D7h/D8h	
N315	360	396	344	378	315	350	332	4465	D4h	D2h/D7h/D8h	
N400	418	460	400	440	400	400	385	5028	D4h	D2h/D7h/D8h	
N450	470	517	450	495	450	450	434	6062	E3h	E1h	E1h
N500	523	575	500	550	500	500	482	6879	E3h	E1h	E1h
N560	596	656	570	627	560	600	549	8076	E3h	E1h	E1h
N630	630	693	630	693	630	650	607	9208	E3h	E1h	E1h
N710	763	839	730	803	710	750	704	10346	E4h	E2h	E2h
N800	889	978	850	935	800	950	819	12723	E4h	E2h	E2h
P710	763	839	730	803	710	750	704	9212	–	F1/ F3	F1/ F3
P800	889	978	850	935	800	950	819	10659	–	F1/ F3	F1/ F3
P900	988	1087	945	1040	900	1050	911	12080	–	F1/ F3	F1/ F3
P1M0	1108	1219	1060	1166	1000	1150	1022	13305	–	F2/ F4	F2/ F4
P1M2	1317	1449	1260	1386	1200	1350	1214	15865	–	F2/ F4	F2/ F4
P1M4	1479	1627	1415	1557	1400	1550	1364	18173	–	F2/ F4	F2/ F4

Dimensions enclosure size D

Enclosure size		VLT® HVAC Drive									
Protection rating [IEC/UL]		IP21 / Type 1 IP54 / Type 12		IP20 / Chassis				IP21 / Type 1 IP54 / Type 12			
[mm]	Height	901.0	1107.0	909.0	1027	1122.0	1294	1324.0	1663.0	1978.0	2284.0
	Width	325.0	420.0	250.0	250.0	350.0	350.0	325.0	325.0	420.0	420.0
	Depth	378.4	378.4	375.0	375.0	375.0	375.0	381.0	381.0	386.0	406.0
[kg]	Weight	62.0	125.0	62.0	108.0	125.0	179.0	99.0	128.0	185.0	232.0
[in]	Height	35.5	43.6	35.8	39.6	44.2	50.0	52.1	65.5	77.9	89.9
	Width	12.8	12.8	19.8	9.9	14.8	13.8	12.8	12.8	16.5	16.5
	Depth	14.9	14.9	14.8	14.8	14.8	14.8	15.0	15.0	15.2	16.0
[lb]	Weight	136.7	275.6	136.7	238.1	275.6	394.6	218.3	282.2	407.9	511.5

⁽¹⁾ Dimensions when used with regeneration or load share terminals

-D5h-D8h can also be configured with Regen terminals

-D6h & D8h can also accept mains disconnect

⁽²⁾ D5h is used with disconnect and/or brake chopper options

⁽³⁾ D6h is used with contactor and/or circuit breaker options

⁽⁴⁾ D7h is used with disconnect and/or brake chopper options

⁽⁵⁾ D8h is used with contactor and/or circuit breaker options

Dimensions enclosure sizes E and F

Frame		VLT® HVAC Drive							
Protection rating [IEC/UL]		IP21 / Type 1 IP54 / Type 12		IP20 / Chassis		IP21 / Type 1 IP54 / Type 12			
[mm]	Height	2043.0	2043.0	1578.0	1578.0	2204.0	2204.0	2204.0	2204.0
	Width	602.0	698.0	506.0	604.0	1400.0	1800.0	2000.0	2400.0
	Depth	513.0	513.0	482.0	482.0	606.0	606.0	606.0	606.0
[kg]	Weight	295.0	318.0	272.0	295.0	1017.0	1260.0	1318.0	1561.0
[in]	Height	80.4	80.4	62.1	62.1	86.8	86.8	86.8	86.8
	Width	23.7	27.5	19.9	23.9	55.2	70.9	78.8	94.5
	Depth	20.2	20.2	19.0	19.0	23.9	23.9	23.9	23.9
[lb]	Weight	650.0	700.0	600.0	650.0	2242.1	2777.9	2905.7	3441.5

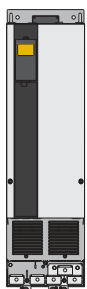

D3h/D4h

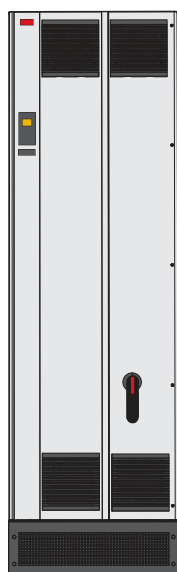

E1h



F

Electrical data and dimensions – VLT® 12-Pulse

[T4] 6 x 380-480 V AC

Type code	Normal overload (110 % 1 min/10 min)							Enclosure size				
	Output current				Typical shaft output power		Continuous input current	Estimated power loss	Protection rating [IEC/UL]			
	(3 x 380-440 V)		(3 x 441-480 V)						IP21/Type 1		IP54/Type 12	
FC-102	Con. I _N	Inter. I _{MAX} (60 s)	Con. I _N	Inter. I _{MAX} (60 s)	kW @ 400 V	Hp @ 460 V	[A] @ 400 V	[W]	Without options	With options	Without options	With options
P315	600	660	540	594	315	450	590	6790	F8	F9	F8	F9
P355	658	724	590	649	355	500	647	7701	F8	F9	F8	F9
P400	745	820	678	746	400	600	733	8879	F8	F9	F8	F9
P450	800	880	730	803	450	600	787	9670	F8	F9	F8	F9
P500	880	968	780	858	500	650	857	10647	F10	F11	F10	F11
P560	990	1089	890	979	560	750	964	12338	F10	F11	F10	F11
P630	1120	1232	1050	1155	630	900	1090	13201	F10	F11	F10	F11
P710	1260	1386	1160	1276	710	1000	1227	15436	F10	F11	F10	F11
P800	1460	1606	1380	1518	800	1200	1422	18084	F12	F13	F12	F13
P1M0	1720	1892	1530	1683	1000	1350	1675	20358	F12	F13	F12	F13

[T7] 6 x 525-690 V AC

Type code	Normal overload (110 % 1 min/10 min)							Enclosure size				
	Output current				Typical shaft output power		Continuous input current	Estimated power loss	Protection rating [IEC/UL]			
	(3 x 525-550 V)		(3 x 551-690 V)						IP21/Type 1		IP54/Type 12	
FC-102	Con. I _N	Inter. I _{MAX} (60 s)	Con. I _N	Inter. I _{MAX} (60 s)	kW @ 690 V	Hp @ 575 V	[A] @ 690 V	[W]	Without options	With options	Without options	With options
P450	470	517	450	495	450	450	434	5529	F8	F9	F8	F9
P500	523	575	500	550	500	500	482	6239	F8	F9	F8	F9
P560	596	656	570	627	560	600	549	7653	F8	F9	F8	F9
P630	630	693	630	693	630	650	607	8495	F8	F9	F8	F9
P710	763	839	730	803	710	750	711	9863	F10	F11	F10	F11
P800	889	978	850	935	800	950	828	11304	F10	F11	F10	F11
P900	988	1087	945	1040	900	1050	920	12798	F10	F11	F10	F11
P1M0	1108	1219	1060	1166	1000	1150	1032	13801	F12	F13	F12	F13
P1M2	1317	1449	1260	1386	1200	1350	1227	16821	F12	F13	F12	F13
P1M4	1479	1627	1415	1557	1400	1550	1378	19247	F12	F13	F12	F13

Dimensions enclosure size F

		VLT® HVAC Drive					
Enclosure size		F8	F9	F10	F11	F12	F13
Protection rating [IEC/UL]		IP21/Type 1 IP54/Type 12					
[mm]	Height	2204.0	2204.0	2204.0	2204.0	2204.0	2204.0
	Width	800.0	1400.0	1600.0	2400.0	2000.0	2800.0
	Depth	606.0	606.0	606.0	606.0	606.0	606.0
[kg]	Weight	447.0	669.0	893.0	1116.0	1037.0	1259.0
[in]	Height	86.8	86.8	86.8	86.8	86.8	86.8
	Width	31.5	55.2	63.0	94.5	78.8	110.2
	Depth	23.9	23.9	23.9	23.9	23.9	23.9
[lb]	Weight	985.5	1474.9	1968.8	2460.4	2286.4	2775.7

Electrical data & dimensions

– VLT® Low Harmonic Drive and VLT® Advanced Active Filters

[T4] 3 x 380 - 480 V AC – VLT® Low Harmonic Drive

Type code	Normal overload (110 % 1 min/10 min)								Enclosure size	
	Output current				Typical shaft output power		Continuous input current	Estimated power loss	Protection rating [IEC/UL]	
	(3 x 380-440 V)		(3 x 441-480 V)		kW @ 400 V	Hp @ 460 V			IP21	IP54
Con. I _N	Inter. I _{MAX} (60 s)	Con. I _N	Inter. I _{MAX} (60 s)	[A] @ 400 V			[W]	Type 1		
N160	315	347	302	332	160	250	304	8725	D1n	D1n
N200	395	435	361	397	200	300	381	9831	D2n	D2n
N250	480	528	443	487	250	350	463	11371	D2n	D2n
P315	600	660	540	594	315	450	590	14051	E9	E9
P355	658	724	590	649	355	500	647	15320	E9	E9
P400	745	820	678	746	400	600	733	17180	E9	E9
P450	800	880	730	803	450	600	787	18447	E9	E9

[T4] 3 x 380-480 V AC VLT® Advanced Active Filter

Type code	Normal overload (110 % 1 min/10min automatically regulated)									Enclosure size		
	Corrected Current								Recommended fuse and disconnect*	Estimated power loss	Protection rating [IEC/UL]	
	@ 400 V		@ 460 V		@ 480 V		@ 500 V				IP21	IP54
Cont.	Int.	Cont.	Int.	Cont.	Int.	Cont.	Int.	[A]	[W]	Type 1		
AAF006	260	390	240	360	260	390	240	360	350	5000	D14	D14
A190	315	473	302	453	315	473	302	453	630	7000	E1	E1
A250	395	593	361	542	395	593	361	542	630	9000	E1	E1
A310	480	720	443	665	480	720	443	665	900	11100	E1	E1

* Built-in options for fuses and disconnect recommended

Dimensions – VLT® Low Harmonic Drive and VLT® Advanced Active Filter

Enclosure size		VLT® Low Harmonic Drive			VLT® Advanced Active Filter	
		D1n	D2n	E9	D14	E1
Protection rating [IEC/UL]		IP21 / Type 1 IP54 / Type 12			IP21 / Type 1 IP54 / Type 12	
[mm]	Height	1780	1780	2000.7	1780.0	2000.0
	Width	929.2	1024.2	1200.0	600.0	600.0
	Depth	418.4	418.4	538.0	418.4	538.0
[kg]	Weight	353.0	413.0	676.0	238.0	453.0
[in]	Height	70	70	78.8	70.0	78.7
	Width	36.6	40.3	47.2	23.6	23.6
	Depth	16.5	16.5	21.0	16.5	21.0
[lb]	Weight	777.0	910.0	1490.0	524.7	998.7

Specifications VLT® Advanced Active Filter

Filter type	3P/3W, Active Shunt Filter (TN, TT, IT)
Frequency	50 to 60 Hz, ± 5 %
Enclosures	IP 21 – NEMA 1, IP 54 – NEMA 12
Max. voltage pre-distortion	10 % 20 % with reduced performance
Operating temperature	0-40° C +5° C with reduced performance -10° C with reduced performance
Altitude	1000 m without derating 3000 m with reduced performance (5 %/1000 m)
EMC standards	IEC61000-6-2 IEC61000-6-4
Circuitry coating	Conformal coated – per ISA S71.04-1985, class G3
Languages	27 different
Harmonic compensation modes	Selective or overall (90 % RMS for harmonic reduction)
Harmonic compensation spectrum	2 nd to 40 th in overall mode, including triplens 5 th , 7 th , 11 th , 13 th , 17 th , 19 th , 23 rd , 25 th in selective mode

Individual harmonic current allocation in selective mode	I5: 63 %, I7: 45 %, I11: 29 %, I13: 25 %, I17: 18 %, I19: 16 %, I23: 14 %, I25: 13 %
Reactive current compensation	Yes, leading (capacitive) or lagging (inductive) to target power factor
Flicker reduction	Yes
Compensation priority	Programmable to harmonics or displacement power factor
Paralleling option	Up to 4 units of same power rating in master follower
Current Transformer Support (Customer supply and field mounting)	1 A and 5 A secondary with auto tuning Class 0.5 or better
Digital inputs /outputs	4 (2 programmable) Programmable PNP or NPN logic
Communication interface	RS485, USB1.1
Control type	Direct harmonic control (for faster response)
Response time	< 0,5 ms (including HW)
Harmonic settling time (5-95 %)	< 15 ms
Reactive settling time (5-95 %)	< 15 ms
Maximum overshoot	5 %
Switching frequency	Progressive control in the range of 3 – 18 kHz
Average switching frequency	3 – 4.5 kHz



VLT® Advanced Active Filter AAF 006

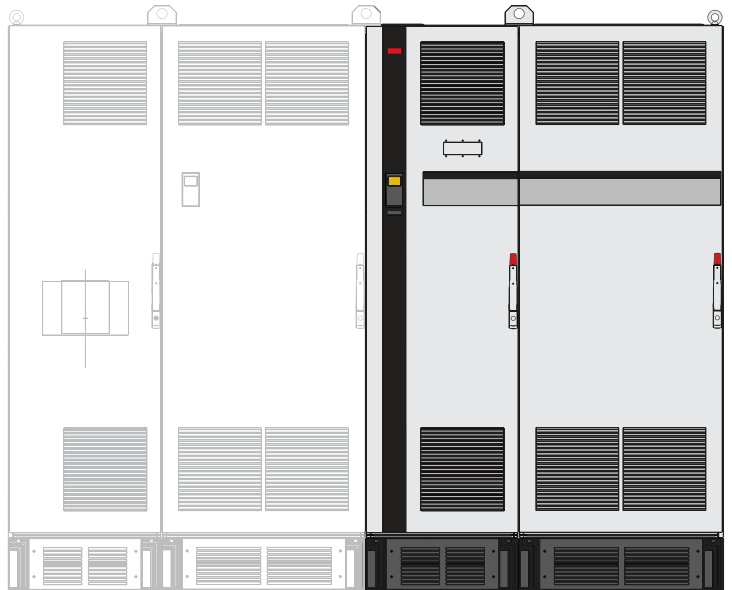

VLT® Low Harmonic Drive

Type code VLT® Advanced Active Filter

The different VLT® Active Filters can easily be configured according to customer request at drives.danfoss.com

1	2	3	4	5	6	7	8	9	10	11	12	13	14	15	16	17	18	19	20	21	22	23	24	..	39
A	A	F	0	0	6	A	x	x	x	T	4	E	x	x	H	x	x	G	C	x	x	x	S	.	X
8-10: 190: 190 A correction current 250: 250 A correction current 310: 310 A correction current 400: 400 A correction current					13-15: E21: IP 21/NEMA 1 E2M: IP 21/NEMA 1 w. mains shield C2M: IP 21/NEMA 1 w. stainless steel back-channel and mains shield					E54: IP 54/NEMA 12 E5M: IP 54/NEMA 12 w. mains shield C5M: IP 54/NEMA 12 w. stainless steel back-channel and mains shield					16-17: HX: No RFI Filter H4: RFI class A1			21: X: No mains options 3: Disconnect & Fuse 7: Fuse							

Electrical data for Enclosed Drive

[T4] 3 x 380-480 V AC – normal overload

Normal overload (110 % 1 min/10 min)									Enclosure size	
Type code	Output current				Typical shaft output power		Estimated power loss	Continuous input current	Protection rating	
	(3 x 380-440 V)		(3 x 441-480 V)						IP21	IP54
FC-102	Con. I _N	Inter. I _{MAX} (60 s)	Con. I _N	Inter. I _{MAX} (60 s)	kW @ 400 V	Hp @ 460 V	[W]	[A]	NEMA 1	NEMA 12
N110	212	233	190	209	110	150	2559	204	D9h	D9h
N132	260	286	240	264	132	200	2954	251	D9h	D9h
N160	315	347	302	332	160	250	3770	304	D9h	D9h
N200	395	435	361	397	200	300	4116	381	D10h	D10h
N250	480	528	443	487	250	350	5137	463	D10h	D10h
N315	588	647	535	588	315	450	6674	578	D10h	D10h
N355	658	724	590	649	355	500	6928	634	E5h	E5h
N400	745	820	678	746	400	600	8036	718	E5h	E5h
N450	800	880	730	803	450	600	8783	771	E5h	E5h
N500	880	968	780	858	500	650	9473	848	E6h	E6h
N560	990	1089	890	979	560	750	11102	954	E6h	E6h

[T7] 3 x 525-690 V AC – normal overload

Normal overload (110 % 1 min/10 min)									Enclosure size	
Type code	Output current				Typical shaft output power		Estimated power loss	Continuous input current	Protection rating	
	(3 x 525-550 V)		(3 x 551-690 V)						IP21	IP54
FC-102	Con. I _N	Inter. I _{MAX} (60 s)	Con. I _N	Inter. I _{MAX} (60 s)	kW @ 690 V	Hp @ 575 V	[W]	[A]	NEMA 1	NEMA 12
N110	137	151	131	144	110	125	1796	132	D9h	D9h
N132	162	178	155	171	132	150	2165	156	D9h	D9h
N160	201	221	192	211	160	200	2738	193	D9h	D9h
N200	253	278	242	266	200	250	3172	244	D10h	D10h
N250	303	333	290	319	250	300	3848	292	D10h	D10h
N315	360	396	344	378	315	350	4610	347	D10h	D10h
N355	418	460	400	440	400	400	5150	381	D10h	D10h
N400	470	517	450	495	450	450	6062	413	E5h	E5h
N500	523	575	500	550	500	500	6879	504	E5h	E5h
N560	596	656	570	627	560	600	8076	574	E5h	E5h
N630	630	693	630	693	630	650	9208	635	E5h	E5h
N710	763	839	730	803	710	750	10346	735	E6h	E6h
N800	889	978	850	935	800	950	12723	857	E6h	E6h

Dimensions for Enclosed Drive

VLT® HVAC Drive				
	D9h	D10h	E5h	E6h
Enclosed Drive				
Rated power at 380–500 V [kW (hp)]	90–132 (125–200)	160–250 (250–350)	315–400 (450–550)	450–500 (600–650)
Rated power at 525–690 V [kW (hp)]	90–132 (100–150)	160–315 (200–350)	355–560 (400–600)	630–710 (650–950)
Protection rating	IP21/NEMA 1 IP54/NEMA 12	IP21/NEMA 1 IP54/NEMA 12	IP21/NEMA 1 IP54/NEMA 12	IP21/NEMA 1 IP54/NEMA 12
Drive cabinet				
Height [mm (in)] ¹⁾	2100 (82.7)	2100 (82.7)	2100 (82.7)	2100 (82.7)
Width [mm (in)] ²⁾	400 (15.8)	600 (23.6)	600 (23.6)	800 (31.5)
Depth [mm (in)]	600 (23.6)	600 (23.6)	600 (23.6)	600 (23.6)
Weight [kg (lb)] ²⁾	280 (617)	355 (783)	400 (882)	431 (950)
Input filter cabinet				
Height [mm (in)] ¹⁾	2100 (82.7)	2100 (82.7)	2100 (82.7)	2100 (82.7)
Width [mm (in)]	400 (15.8)	400 (15.8)/ 600 (23.6)	600 (23.6)	600 (23.6)/ 800 (31.5)
Depth [mm (in)]	600 (23.6)	600 (23.6)	600 (23.6)	600 (23.6)
Weight [kg (lb)]	410 (904)	410 (904)/ 530 (1168)	530 (1168)	530 (1168)/ 955 (215)
Input Power Options Cabinet				
Height [mm (in)] ¹⁾	–	2100 (82.7)	2100 (82.7)	2100 (82.7)
Width [mm (in)]	–	600 (23.6)	600 (23.6)	600 (23.6)
Depth [mm (in)]	–	600 (23.6)	600 (23.6)	600 (23.6)
Weight [kg (lb)]	–	380 (838)	380 (838)	380 (838)
Sine-wave filter cabinet				
Height [mm (in)] ¹⁾	2100 (82.7)	2100 (82.7)	2100 (82.7)	2100 (82.7)
Width [mm (in)]	600 (23.6)	600 (23.6)	1200 (47.2)	1200 (47.2)
Depth [mm (in)]	600 (23.6)	600 (23.6)	600 (23.6)	600 (23.6)
Weight [kg (lb)]				
dV/dt filter cabinet				
Height [mm (in)] ¹⁾	–	–	2100 (82.7)	2100 (82.7)
Width [mm (in)] ³⁾	–	–	400 (15.8)	400 (15.8)
Depth [mm (in)]	–	–	600 (23.6)	600 (23.6)
Weight [kg (lb)]	–	–	240 (529)	240 (529)
Top entry/exit cabinet				
Height [mm (in)] ¹⁾	2100 (82.7)	2100 (82.7)	2100 (82.7)	2100 (82.7)
Width [mm (in)] ³⁾	400 (15.8)	400 (15.8)	400 (15.8)	400 (15.8)
Depth [mm (in)]	600 (23.6)	600 (23.6)	600 (23.6)	600 (23.6)
Weight [kg (lb)]	164 (362)	164 (362)	164 (362)	164 (362)

¹⁾ Cabinet height includes standard 100 mm (3.9 in) plinth. A 200 mm (7.9 in) or 400 mm (15.8 in) plinth is optional.

²⁾ Without options.

³⁾ The E5h and E6h enclosures contain 2 sine wave cabinets. The provided width is the total of both cabinets.



A options: Fieldbuses

Available for the full product range

Fieldbus	Type code position
A	
VLT® PROFIBUS DP MCA 101	14
VLT® DeviceNet MCA 104	
VLT® LonWorks MCA 108	
VLT® BACnet MCA 109	
VLT® PROFINET MCA 120	
VLT® EtherNet/IP MCA 121	
VLT® Modbus TCP MCA 122	
VLT® BACnet/IP MCA 125	

PROFIBUS DP

Operating the AC drive via a fieldbus enables you to reduce the cost of your system, communicate faster and more efficiently and benefit from an easier user interface.

Other features:

- Wide compatibility, a high level of availability, support for all major PLC vendors, and compatibility with future versions
- Fast, efficient communication, transparent installation, advanced diagnosis and parameterization and auto-configuration of process data via GSD-file
- Acyclic parameterization using PROFIBUS DP-V1, PROFIdrive or Danfoss FC (MCA101 only) profile state machines, PROFIBUS DP-V1, Master Class 1 and 2

VLT® PROFIBUS DP MCA 101

Order code

130B1100 standard
130B1200 coated

DeviceNet

DeviceNet offers robust, efficient data handling thanks to advanced Producer/Consumer technology.

- Support of ODVA's AC drive profile supported via I/O instance 20/70 and 21/71 secures compatibility to existing systems
- Benefit from ODVA's strong conformance testing policies, which ensure that products are interoperable

VLT® DeviceNet MCA 104

Order code

130B1102 standard
130B1202 coated

LonWorks

LonWorks is a fieldbus system developed for building automation. It enables communication between individual units in the same system (peer-to-peer) and thus supports decentralizing of control.

- No need for main station (master-follower)
- Supports echelon free-topology interface
- Supports embedded I/O and I/O options
- Sensor signals can quickly be moved to another controller via bus cables
- Certified as compliant with LonMark ver. 3.4 specifications (VLT® LonWorks MCA 108 only)

VLT® LonWorks MCA 108

Order code

130B1106 standard
130B1206 coated

BACnet MS/TP

The BACnet protocol is an international protocol that efficiently integrates all parts of building automation equipment from the actuator level to the building management system.

Via the BACnet option, it is possible to read all analog and digital inputs and control all analog and digital outputs of the VLT® HVAC Drive and VACON® NXS.

All inputs and outputs can be operated independently of the functions of the drive, and thus work as remote I/O:

Other features:

- COV (Change of Value)
- Synchronization of RTC from BACnet
- Read/write property multiple
- Alarm/warning handling

VLT® BACnet MCA 109

Order code

130B1144 standard
130B1244 coated

PROFINET

PROFINET uniquely combines the highest performance with the highest degree of openness. The option is designed so that many of the features from the PROFIBUS can be reused, minimizing user effort to migrate PROFIBUS and securing the investment in a PLC program.

- Same PPO types as PROFIBUS for easy migration to PROFIBUS
- Support of MRP
- Support of DP-V1 Diagnostic allows easy, fast and standardized handling of warning and fault information into the PLC, improving bandwidth in the system
- Implementation in accordance with Conformance Class B

VLT® PROFINET MCA 120

Order code

130B1135 standard, dual-port
130B1235 coated, dual-port

EtherNet/IP

Ethernet is the future standard for communication at the factory floor. EtherNet/IP is based on the newest technology available for industrial use and handles even the most demanding requirements.

EtherNet/IP™ extends commercial off-the-shelf Ethernet to the Common Industrial Protocol (CIP™) – the same upper-layer protocol and object model found in DeviceNet.

The option offers advanced features such as:

- Built-in high performance switch enabling line-topology, and eliminating the need for external switches
- DLR Ring
- Advanced switch and diagnosis functions
- Built-in web server
- E-mail client for service notification
- Unicast and Multicast communication

VLT® EtherNet/IP MCA 121

Order code

130B1119 standard, dual-port
130B1219 coated, dual-port

Modbus TCP

Modbus TCP is the first industrial Ethernet-based protocol for automation. Modbus TCP is able to handle connection intervals down to 5 ms in both directions, positioning it among the fastest performing Modbus TCP devices in the market. For master redundancy, it features hot swapping between two masters.

Other features:

- Dual Master PLC connection for redundancy in dual port options (MCA 122 only)

VLT® Modbus TCP MCA 122

Order code

130B1196 standard, dual-port
130B1296 coated, dual-port

BACnet/IP

The BACnet/IP option optimizes the use of VLT® HVAC Drive together with building management systems (BMS) using the BACnet/IP protocol or running BACnet on Ethernet. BACnet/IP makes it easy to control or to monitor points required in typical HVAC applications, reducing overall cost of ownership.

Other features:

- COV, Change Of Value
- Read/WritePropertyMultiple
- Alarm/Warning notifications
- PID Loop object
- Segmented data transfer
- Trend Objects
- Schedule Objects

VLT® BACnet/IP MCA 125

Order code

134B1586 coated, dual-port

B options: Functional extensions

Available for the full product range

Functional extensions	Type code position
B	
VLT® General Purpose MCB 101	15
VLT® Relay Option MCB 105	
VLT® Programmable I/O MCB 115	
VLT® Analog I/O Option MCB 109	
VLT® PTC Thermistor Card MCB 112	
VLT® Sensor Input Card MCB 114	
VLT® Safety Option MCB 140	

VLT® General Purpose I/O MCB 101

This I/O option offers an extended number of control inputs and outputs:

- 3 digital inputs 0-24 V: Logic '0' < 5 V; Logic '1' > 10V
- 2 analog inputs 0-10 V: Resolution 10 bit plus sign
- 2 digital outputs NPN/PNP push pull
- 1 analog output 0/4-20 mA
- Spring-loaded connection

Ordering number

130B1125 standard
130B1212 coated (Class 3C3/IEC 60721-3-3)

VLT® Relay Card MCB 105

Makes it possible to extend relay functions with 3 additional relay outputs.

- Max. switch rate at rated load/min. load6 min⁻¹/20 sec⁻¹
- Protects control cable connection
- Spring-loaded control wire connection

Max. terminal load:

- AC-1 Resistive load240 V AC 2 A
- AC-15 Inductive load @cos phi 0.4240 V AC 0.2 A
- DC-1 Resistive load24 V DC 1 A
- DC-13 Inductive load @cos phi 0.424 V DC 0.1 A

Min. terminal load:

- DC 5 V10 mA

Ordering number

130B1110 standard
130B1210 coated (Class 3C3/IEC 60721-3-3)

VLT® Analog I/O Option MCB 109

This analog input/output option is easily fitted in the AC drive for upgrading to advanced performance and control using the additional I/O. This option also upgrades the AC drive with a battery back-up supply for the AC drive built-in clock. This provides stable use of all AC drive clock functions as timed actions.

- 3 analog inputs, each configurable as both voltage and temperature input
- Connection of 0-10 V analog signals as well as Pt1000 and Ni1000 temperature inputs
- 3 analog outputs each configurable as 0-10 V outputs
- Back-up supply for the standard clock function in the AC drive

The back-up battery typically lasts for 10 years, depending on environment.

Ordering number

130B1143 standard
130B1243 coated (Class 3C3/IEC 60721-3-3)

VLT® PTC Thermistor Card MCB 112

The VLT® PTC Thermistor Card MCB 112 enables improved surveillance of the motor condition compared to the built-in ETR function and thermistor terminal.

- Protects the motor from overheating
- ATEX-approved for use with Ex d and Ex e motors (EX e only FC 302)
- Uses Safe Stop function, which is approved in accordance with SIL 2 IEC 61508

Ordering number

NA standard
130B1137 coated (Class 3C3/IEC 60721-3-3)

VLT® Sensor Input Card MCB 114

This option protects the motor from being overheated by monitoring the temperature of bearings and windings in the motor.

- Protects the motor from overheating
- 3 self-detecting sensor inputs for 2 or 3 wire PT100/PT1000 sensors
- 1 additional analog input 4-20 mA

Ordering number

130B1172 standard
130B1272 coated (Class 3C3/IEC 60721-3-3)

C options: Relay card

Available for the full product range

Motion control and relay card	Type code position
C	
VLT® Extended Relay Card MCB 113	17

VLT® Extended Relay Card MCB 113

The VLT® Extended Relay Card MCB 113 adds inputs/outputs for increased flexibility.

- 7 digital inputs
- 2 analog outputs
- 4 SPDT relays
- Meets NAMUR recommendations

- Galvanic isolation capability
- Support is added in FW 17A for the MCO 301 option
- Allows customers to move PLC functionality found in AHU systems, for example, to the HVAC Drive

Ordering number

130B1164 standard
130B1264 coated (Class 3C3/IEC 60721-3-3)

D option: 24 V back-up power supply

Available for the full product range

24 V back-up power supply	Type code position
D	
VLT® 24 V DC Supply Option MCB 107	19

VLT® 24 V DC Supply MCB 107

Connect an external DC supply to keep the control section and any installed option functioning during power failure.

This enables full operation of the LCP (including the parameter setting) and all installed options without connection to mains.

- Input voltage range..... 24 V DC +/- 15 %
(max. 37 V for 10 sec.)
- Max. input current 2.2 A
- Max. cable length 75 m
- Input capacitance load < 10 uF
- Power-up delay < 0.6 s

Ordering number

130B1108 standard
130B1208 coated (Class 3C3/IEC 60721-3-3)

VLT® Real-time Clock MCB 117

The option provides advanced data-logging functionality. It allows events to be time and date stamped, providing vast amounts of actionable data. The option keeps the drive updated with daily date and real-time data.

- Battery back up for long-term time and date registration, even after power cycling the drive.
- Programmable both locally and remotely via option
- Advanced data logging using real-time stamps

Ordering number

134B6544 coated ((Class 3C3/IEC 60721-3-3))

Power options

Power option

VLT® Sine-Wave Filter MCC 101

VLT® dU/dt Filter MCC 102

VLT® Common Mode Filters MCC 105

VLT® Advanced Harmonic Filter AHF 005/010

VLT® Brake Resistors MCE 101

VLT® Line Reactor MCC 103

VLT® All-mode Filter MCC 201

VLT® Sine-wave Filter MCC 101

- VLT® Sine-wave Filters are positioned between the AC drive and the motor to provide a sinusoidal phase-to-phase motor voltage
- Reduces motor insulation stress
- Reduces acoustic noise from the motor
- Reduces bearing currents (especially in large motors)
- Reduces losses in the motor Prolongs service lifetime
- VLT® FC series family look

Power range

3 x 200-500 V, 2.5-800 A
3 x 525-690 V, 4.5-660 A

Enclosure ratings

- IP00 and IP20 wall-mounted enclosures rated up to 75 A (500 V) or 45 A (690 V)
- IP23 floor-mounted enclosures rated 115 A (500 V) or 76 A (690 V) or more
- IP54 both wall-mounted and floor-mounted enclosures rated up to 4.5 A, 10 A, 22 A (690 V)

Ordering number

See relevant Design Guide

VLT® dU/dt Filter MCC 102

- Reduces the dU/dt values on the motor terminal phase-to-phase voltage
- Positioned between the AC drive and the motor to eliminate very fast voltage changes
- The motor terminal phase-to-phase voltage is still pulse shaped but its dU/dt values are reduced
- Reduces stress on the motor's insulation and are recommended in applications with older motors, aggressive environments or frequent braking which cause increased DC link voltage
- VLT® FC series family look

Power range

3 x 200-690 V (up to 880 A)

Enclosure ratings

- IP00 and IP20/IP23 enclosure in the entire power range
- IP54 enclosure available up to 177 A

Ordering number

See relevant Design Guide

VLT® Common Mode Filter MCC 105

- Positioned between the AC drive and the motor
- They are nano-crystalline cores that mitigate high frequency noise in the motor cable (shielded or unshielded) and reduce bearing currents in the motor
- Extends motor bearing lifetime
- Can be combined with dU/dt and sine-wave filters
- Reduces radiated emissions from the motor cable
- Reduces electromagnetic interference
- Easy to install – no adjustments necessary
- Oval shaped – allows mounting inside the AC drive enclosure or motor terminal box

Power range

380-415 V AC (50 and 60 Hz)
440-480 V AC (60 Hz)
600 V AC (60 Hz)
500-690 V AC (50 Hz)

Ordering number

130B3257 Enclosure size A and B
130B7679 Enclosure size C1
130B3258 Enclosure size C2, C3 and C4
130B3259 Enclosure size D
130B3260 Enclosure size E and F

VLT® Advanced Harmonic Filter AHF 005 and AHF 010

- Optimized harmonic performance for VLT® drives rated up to 250 kW
- A patented technique reduces THD levels in the mains network to less than 5-10 %
- Perfect match for industrial automation, highly dynamic applications and safety installations
- Intelligent cooling by using variable speed fan

Power range

380-415 V AC (50 and 60 Hz)
440-480 V AC (60 Hz)
600 V AC (60 Hz)
500-690 V AC (50 Hz)

Enclosure ratings

- IP20
(An IP21/NEMA 1 upgrade kit is available)

Ordering number

See relevant Design Guide

VLT® Brake Resistor MCE 101

- Energy generated during braking is absorbed by the resistors, protecting electrical components from heating up
- Optimized for the FC-series and general versions for horizontal and vertical motion are available
- Built-in thermo switch
- Versions for vertical and horizontal mounting
- A selection of the vertically mounted units are UL-recognized

Power range

Precision electrical match to each individual VLT® drive power size

Enclosure ratings:

- IP20
- IP21
- IP54
- IP65

Ordering number

See relevant Design Guide

VLT® Line Reactor MCC 103

- Ensures current balance in load-sharing applications, where the DC-side of the rectifier of multiple drives is connected together
- UL-recognized for applications using load sharing
- When planning load-sharing applications, pay special attention to different enclosure type combinations and inrush concepts
- For technical advice regarding load-sharing applications, contact Danfoss application support
- Compatible with VLT® HVAC Drive 50 Hz or 60 Hz mains supply

Ordering number

See relevant Design Guide

VLT® All-mode Filter MCC 201

Ensures true sinusoidal power supply to the motor, which

- Reduces acoustical switching noise from motor
- Improves conducted emissions
- Eliminates motor bearing currents
- Extends motor service life
- Up to 1000 m unshielded motor cable

Ordering number

See relevant Design Guide

Accessories

Available for the full product range

LCP

VLT® Control Panel LCP 101 (Numeric)
Ordering number: 130B1124

VLT® Control Panel LCP 102 (Graphical)
Ordering number: 130B1107

VLT® Wireless Communication Panel LCP 103
Certified for Europe, US and India. More countries are in the process of certification - contact Danfoss for more information.
Ordering number: 134B0460

LCP Panel Mounting Kit

Ordering number for IP20 enclosure

130B1113: With fasteners, gasket, graphical LCP and 3 m cable
130B1114: With fasteners, gasket, numerical LCP and 3 m cable
130B1117: With fasteners, gasket and without LCP and with 3 m cable
130B1170: With fasteners, gasket and without LCP

Ordering number for IP55 enclosure

130B1129: With fasteners, gasket, blind cover and 8 m "free end" cable

LCP Remote Mounting Kit

Ordering number:

134B5223 – Kit with 3 m cable*
134B5224 – Kit with 5 m cable*
134B5225 – Kit with 10 m cable*
* Delivery excludes the LCP 103.



LCP Remote Mounting Kit

PC software

VLT® Motion Control Tool MCT 10

VLT® Motion Control Tool MCT 31

Danfoss HCS

VLT® Energy Box

VLT® Software Customizer

MyDrive® Suite

MyDrive® ecoSmart™

MyDrive® Select

MyDrive® Connect

MyDrive® Harmonics

Accessories

PROFIBUS SUB-D9 Adapter

IP20, A2 and A3

Ordering number: 130B1112

Option Adapter

Ordering number: 130B1130 standard, 130B1230 coated

Adapter Plate for VLT® 3000 and VLT® 5000

Ordering number: 130B0524 – to be used only for IP20/NEMA type 1 units up to 7.5 kW

USB Extension

Ordering number:

130B1155: 350 mm cable

130B1156: 650 mm cable

IP21/Type 1 (NEMA 1) kit

Ordering number

130B1121: For enclosure size size A1

130B1122: For enclosure size size A2

130B1123: For enclosure size size A3

130B1187: For enclosure size size B3

130B1189: For enclosure size size B4

130B1191: For enclosure size size C3

130B1193: For enclosure size size C4

NEMA 3R outdoor weather shield

Ordering number

176F6302: For enclosure size size D1h

176F6303: For enclosure size size D2h

NEMA 4X outdoor weather shield

Ordering number

130B4598: For enclosure size size A4, A5, B1, B2

130B4597: For enclosure size size C1, C2

Motor connector

Ordering number:

130B1065: enclosure size A2 to A5 (10 pieces)

Mains connector

Ordering number:

130B1066: 10 pieces mains connectors IP55

130B1067: 10 pieces mains connectors IP20/21

Relays 1 terminal

Ordering number: 130B1069 (10 pieces 3 pole connectors for relay 01)

Relays 2 terminal

Ordering number: 130B1068 (10 pieces 3 pole connectors for relay 02)

Control card terminals

Ordering number: 130B0295

VLT® Leakage Current Monitor Module RCMB20/RCMB35

Ordering number:

130B5645: A2-A3

130B5764: B3

130B5765: B4

130B6226: C3

130B5647: C4

VLT® Pressure Transmitter PTU 025

Ordering number:

134B5925



Accessory compatibility with enclosure size

Overview for enclosure sizes D, E and F only

Enclosure size	Type code position	D1h/D2h	D3h/D4h	D5h/D7h	D6h/D8h	D1n/D2n	E1h/E2h	E3h/E4h	E9	F1/F2	F3/F4 (w/options cabinet)	F8	F9 (w/options cabinet)	F10/F12	F11/F13 (w/options cabinet)
Enclosure with corrosion-resistant back channel	4	-	□	-	-	-	□	□	-	□	□	-	-	-	-
Mains shielding	4	□	-	□	□	□	□	-	□	■	■	■	■	■	■
Space heaters and thermostat	4	□	-	□	□	-	□	-	-	□	□	-	-	□	□
Cabinet light with power outlet	4	-	-	-	-	-	-	-	-	□	□	-	-	□	□
RFI filters ^(*)	5	□	□	□	□	□	□	□	□	-	□	-	□	-	□
Insulation Resistance Monitor (IRM)	5	-	-	-	-	-	-	-	-	-	□	-	□	-	□
Residual Current Device (RCD)	5	-	-	-	-	-	-	-	-	-	□	-	□	-	□
Brake Chopper (IGBTs)	6	-	□	□	□	□	□	□	□	□	□	□	□	□	□
Safe Torque Off with Pilz Safety Relay	6	□	□	□	□	□	□	□	□	□	□	□	□	□	□
Regeneration terminals	6	-	□	□	□	□	□	□	□	□	□	□	□	□	□
Common Motor Terminals	6	■	■	■	■	■	■	■	■	□	□	■	■	□	□
Emergency Stop with Pilz Safety Relay	6	-	-	-	-	-	-	-	-	-	□	-	-	-	-
Safe Torque Off + Pilz Safety Relay	6	-	-	-	-	-	-	-	-	□	□	□	□	□	□
No LCP	7	□	□	□	□	-	□	□	-	-	-	-	-	-	-
VLT® Control Panel LCP 101 (Numeric)	7	□	□	□	□	-	-	-	-	-	-	-	-	-	-
VLT® Control Panel LCP 102 (Graphical)	7	□	□	□	□	■	■	■	■	■	■	■	■	■	■
Fuses	9	□	□	□	■	□	■	□	□	□	□	□	□	□	□
Load sharing terminals	9	-	□	-	-	-	-	□	-	□	□	-	-	-	-
Fuses + load sharing terminals	9	-	□	-	-	-	-	□	-	□	□	-	-	-	-
Disconnect	9 ⁽¹⁾	-	-	□	□	□	□	□	□	-	□	-	□	-	□
Circuit breakers	9 ⁽¹⁾	-	-	-	□	-	-	-	-	-	□	-	-	-	-
Contactors	9 ⁽¹⁾	-	-	-	□	-	-	-	-	-	□	-	-	-	-
Manual motor starters	10	-	-	-	-	-	-	-	-	□	□	-	-	□	□
30 A, fuse-protected terminals	10	-	-	-	-	-	-	-	-	□	□	-	-	□	□
24V DC supply	11	-	-	-	-	-	-	-	-	□	□	-	-	□	□
External temperature monitoring	11	-	-	-	-	-	-	-	-	□	□	-	-	□	□
Heat sink access panel	11	□	□	□	□	-	□	□	-	-	-	-	-	-	-
NEMA 3R ready drive	11	□	-	-	-	-	-	-	-	-	-	-	-	-	-

⁽¹⁾ Options supplied with fuses

^(*) Not available in 690 V

□ Optional

■ Standard; Comes with Contactor/Circuit Breaker

Enclosure with corrosion-resistant back channel

For additional protection from corrosion in harsh environments, units can be ordered in an enclosure that includes a corrosion-resistant back channel, heavier plated heat sinks and an upgraded fan.

Mains shielding

Lexan® shielding can be mounted in front of incoming power terminals and input plate to protect from accidental contact when the enclosure door is open.

Space heaters and thermostat

Mounted in the cabinet interior of drives with enclosure sizes D and F and controlled via an automatic thermostat, space heaters controlled via an automatic thermostat prevent condensation inside the enclosure.

The thermostat default settings turn on the heaters at 10°C (50° F) and turn them off at 15.6°C (60° F).

Cabinet light with power outlet

A light can be mounted on the cabinet interior of drives with enclosure size F, to increase visibility during servicing and maintenance. The light housing includes a power outlet for temporarily powering laptop computers or other devices. Available in two voltages:

- 230 V, 50 Hz, 2.5 A, CE/ENEC
- 120 V, 60 Hz, 5 A, UL/cUL

RFI filters

VLT® Series drives feature integrated Class A2 RFI filters as standard. If additional levels of RFI/EMC protection are required, they can be obtained using optional Class A1 RFI filters, which provide suppression of radio frequency interference and electromagnetic radiation in accordance with EN 55011.

On drives with enclosure size F, the Class A1 RFI filter requires the addition of the options cabinet. Marine use RFI filters are also available.

Insulation Resistance Monitor (IRM)

Monitors the insulation resistance in ungrounded systems (IT systems in IEC terminology) between the system phase conductors and ground. There is an ohmic pre-warning and a main alarm setpoint for the insulation level. Associated with each setpoint is an SPDT alarm relay for external use. Only one insulation resistance monitor can be connected to each ungrounded (IT) system.

- Integrated into the drive's safe-stop circuit
- LCD display of insulation resistance
- Fault memory
- INFO, TEST and RESET key

Residual Current Device (RCD)

Uses the core balance method to monitor ground fault currents in grounded and high-resistance grounded systems (TN and TT systems in IEC terminology). There is a pre-warning (50 % of main alarm setpoint) and a main alarm setpoint. Associated with each setpoint is an SPDT alarm relay for external use. Requires an external "window-type" current transformer (supplied and installed by customer).

- Integrated into the drive's safe-stop circuit
- IEC 60755 Type B device monitors, pulsed DC, and pure DC ground fault currents
- LED bar graph indicator of the ground fault current level from 10-100 % of the setpoint
- Fault memory
- TEST / RESET key

Safe Torque Off with Pilz Safety Relay

Available for drives with enclosure size F. Enables the Pilz Relay to fit in the enclosure without requiring an options cabinet. The relay is used in the external temperature monitoring option. If PTC monitoring is required, VLT® PTC Thermistor Card MCB 112 must be ordered.

Emergency Stop with Pilz Safety Relay

Includes a redundant 4-wire emergency stop pushbutton mounted on the front of the enclosure, and a Pilz relay that monitors it in conjunction with the drive's safe-stop circuit and contactor position. Requires a contactor and the options cabinet for drives with enclosure size F.

Brake Chopper (IGBTs)

Brake terminals with an IGBT brake chopper circuit allow for the connection of external brake resistors. For detailed data on brake resistors please see the VLT® Brake Resistor MCE 101 Design Guide, MG.90.Ox.yy, available at <http://drivesliterature.danfoss.com/>

Regeneration terminals

Allow connection of regeneration units to the DC bus on the capacitor bank side of the DC-link reactors for regenerative braking. The enclosure size F regeneration terminals are sized for approximately 50 % the power rating of the drive. Consult the factory for regeneration power limits based on the specific drive size and voltage.

Load sharing terminals

These terminals connect to the DC-bus on the rectifier side of the DC-link reactor and allow for the sharing of DC bus power between multiple drives. For drives with enclosure size F, the load sharing terminals are sized for approximately 33 % of the power rating of the drive. Consult the factory for load sharing limits based on the specific drive size and voltage.

Disconnect

A door-mounted handle allows for the manual operation of a power disconnect switch to enable and disable power to the drive, increasing safety during servicing. The disconnect is interlocked with the cabinet doors to prevent them from being opened while power is still applied.

Circuit breakers

A circuit breaker can be remotely tripped, but must be manually reset. Circuit breakers are interlocked with the cabinet doors to prevent them from being opened while power is still applied. When a circuit breaker is ordered as an option, fuses are also included for fast-acting current overload protection of the AC drive.

Contactors

An electrically – controlled contactor switch allows for the remote enabling and disabling of power to the drive. An auxiliary contact on the contactor is monitored by the Pilz Safety if the IEC Emergency Stop option is ordered.

Manual motor starters

Provide 3-phase power for electric cooling blowers that are often required for larger motors. Power for the starters is provided from the load side of any supplied contactor, circuit breaker or disconnect switch. If a Class 1 RFI filter option is ordered, the input side of the RFI provides the power to the starter. Power is fused before each motor starter and is off when the incoming power to the drive is off. Up to two starters are allowed. If a 30 A, fuse-protected circuit is ordered, then only one starter is allowed. Starters are integrated into the drive's safe-stop circuit.

Unit features include:

- Operation switch (on/off)
- Short circuit and overload protection with test function
- Manual reset function

30 A, fuse-protected terminals

- 3-phase power matching incoming mains voltage for powering auxiliary customer equipment
- Not available if two manual motor starters are selected
- Terminals are off when the incoming power to the drive is off
- Power for the fused-protected terminals will be provided from the load side of any supplied contactor, circuit breaker, or disconnect switch. If a Class 1 RFI filter option is ordered, the input side of the RFI provides the power to the starter.

Common Motor Terminals

The common motor terminal option provides the bus bars and hardware required to connect the motor terminals from the paralleled inverters to a single terminal (per phase) to accommodate the installation of the motor-side top entry kit.

This option is also recommended to connect the output of a drive to an output filter or output contactor. The common motor terminals eliminate the need for equal cable lengths from each inverter to the common point of the output filter (or motor).

24 V DC supply

- 5 A, 120 W, 24 V DC
- Protected against output overcurrent, overload, short circuits, and overtemperature
- For powering customer-supplied accessory devices such as sensors, PLC I/O, contactors, temperature probes, indicator lights and/or other electronic hardware
- Diagnostics include a dry DC-ok contact, a green DC-ok LED and a red overload LED

External temperature monitoring

Designed for monitoring temperatures of external system components, such as the motor windings and/or bearings. Includes eight universal input modules plus two dedicated thermistor input modules. All ten modules are integrated into the drive's safe-stop circuit and can be monitored via a fieldbus network, which requires the purchase of a separate module/bus coupler. A Safe Torque Off brake option must be ordered when selecting external temperature monitoring.

Universal inputs (5)

Signal types:

- RTD inputs (including Pt100), 3-wire or 4-wire
- Thermocouple
- Analog current or analog voltage

Additional features:

- One universal output, configurable for analog voltage or analog current
- Two output relays (N.O.)
- Dual-line LC display and LED diagnostics
- Sensor lead wire break, short circuit and incorrect polarity detection
- Interface set-up software
- If 3 PTC are required, MCB 112 control card option must be added.

Additional external temperature monitors:

- This option is available in case you need more than the MCB 114 and MCB 112 provides.

VLT® Control Panel LCP 101 (Numeric)

- Status messages
- Quick menu for easy commissioning
- Parameter setting and adjusting
- Hand-operated start/stop function or selection of Automatic mode
- Reset function

Ordering number
130B1124

VLT® Control Panel LCP 102 (Graphical)

- Multi-language display
- Quick menu for easy commissioning
- Full parameter back-up and copy function
- Alarm logging
- Info key explains the function of the selected item on display
- Hand-operated start/stop or selection of Automatic mode
- Reset function
- Trend graphing

Ordering number
130B1107

Loose kits for enclosure sizes D, E and F

Kit	Available for following enclosure sizes
Space heater kit	E1h, E2h
Cable clamp kit	E3h, E4h
Back-channel cooling kit (in-bottom/out-back)	E3h, E4h
Back-channel cooling kit (in-back/out-top)	E3h, E4h
NEMA 3R outdoor weather shield	D1h, D2h
USB in the door kit	D1h, D2h, D5h, D6h, D7h, D8h, E1h, E2h, F
Enclosure size F top entry kit motor cables	F
Enclosure size F top entry kit mains cables	F
Common motor terminal kits	F1/F2/F3/F4/F10/F11/F12/F13
Adapter plate	D1h, D2h, D3h, D4h
Back-channel duct kit	D1h, D2h, D3h, D4h
NEMA 3R Rittal and welded enclosures	D3h, D4h, E3h, E4h
Back-channel cooling kits for non-Rittal enclosures	D3h, D4h
Back-channel cooling kit (in-bottom/out-top)	D1h, D2h, D3h, D4h, E3h, E4h
Back-channel cooling kit (in-back/out-back)	D1h, D2h, D3h, D4h, D5h, D6h, D7h, D8h, E1h, E2h, E3h, E4h, F1-F12
Pedestal kit with in-back/out-back cooling	D1h, D2h
Pedestal kit	D1h, D2h, D5h, D6h, D7h, D8h, E1h, E2h
Top entry of fieldbus cables	D3, D4, D1h-D8h
LCP Remote Mounting Kit	Available for the full product range
Multiwire kit	D1h, D2h
L-shaped motor busbars kit	D1h, D2h, D3h, D4h
Common mode filter	D1h, D2h, D3h, D4h, D5h, D6h, D7h, D8h

NEMA 3R outdoor weather shield

Designed to be mounted over the VLT® drive to protect from direct sun, snow and falling debris. Drives used with this shield must be ordered from the factory as "NEMA 3R Ready". This is an enclosure option in the type code – E5S.

Ordering number

D1h 176F6302
D2h 176F6303

USB in the door kit

Available for all enclosure sizes, this USB extension cord kit allows access to the drive controls via laptop computer without opening the drive.

The kits can only be applied to drives manufactured after a certain date. Drives built prior to these dates do not have the provisions to accommodate the kits. Reference the following table to determine which drives the kits can be applied to.

IP20

D1h, D2h, D3h, D4h, D5h, D6h, D7h and D8h.

IP21/IP54

D1h, D2h, D3h, D4h, D5h, D6h, D7h, D8h and F.

Enclosure size F top entry kit motor cables

To use this kit, the drive must be ordered with the common motor terminal option. The kit includes everything to install a top entry cabinet on the motor side (right side) of an F size enclosure.

Ordering number

F1/F3, 400 mm 176F1838
F1/F3, 600 mm 176F1839
F2/F4 400 mm 176F1840
F2/F4, 600 mm 176F1841
F8, F9, F10, F11, F12, F13 Contact factory

Enclosure size F top entry kit mains cables

The kits include everything required to install a top entry section onto the mains side (left side) of an F size enclosure.

Ordering number

F1/F2, 400 mm	176F1832
F1/F2, 600 mm	176F1833
F3/F4 with disconnect, 400 mm	176F1834
F3/F4 with disconnect, 600 mm	176F1835
F3/F4 without disconnect, 400 mm	176F1836
F3/F4 without disconnect, 600 mm	176F1837
F8, F9, F10, F11, F12, F13	Contact factory

Common motor terminal kits

The common motor terminal kits provide the bus bars and hardware required to connect the motor terminals from the paralleled inverters to a single terminal (per phase) to accommodate the installation of the motor-side top entry kit. This kit is equivalent to the common motor terminal option of a drive. This kit is not required to install the motor-side top entry kit if the common motor terminal option was specified when the drive was ordered.

This kit is also recommended to connect the output of a drive to an output filter or output contactor. The common motor terminals eliminate the need for equal cable lengths from each inverter to the common point of the output filter (or motor).

Ordering number

F1/F2, 400 mm	176F1832
F1/F2, 600 mm	176F1833

Adapter plate

The adapter plate is used to replace an old enclosure size D drive with the new enclosure size D drive, using the same mounting.

Ordering number

D1h/D3h adapter plate to replace D1/D3 drive.....	176F3409
D2h/D4h adapter plate to replace D2/D4 drive.....	176F3410

Back-channel duct kit

Back-channel duct kits are offered for conversion of enclosure sizes D and E. They are offered in two configurations – in-bottom/out-top venting and top only venting. Available for enclosure sizes D3h and D4h.

Ordering number top and bottom

D3h kit 1800 mm	176F3627
D4h kit 1800 mm	176F3628
D3h Kit 2000 mm	176F3629
D4h Kit 2000 mm	176F3630

NEMA 3R Rittal and welded enclosures

The kits are designed to be used with the IP00/IP20/Chassis drives to achieve an ingress protection rating of NEMA 3R or NEMA 4. These enclosures are intended for outdoor use to provide a degree of protection against inclement weather.

Ordering number for NEMA 3R (welded enclosures)

D3h back-channel cooling kit (in back out back).....	176F3521
D4h back-channel cooling kit (in back out back).....	176F3526

Ordering number for NEMA 3R (Rittal enclosures)

D3h back-channel cooling kit (in back out back).....	176F3633
D4h Back-channel cooling kit (in back out back).....	176F3634

Back-channel cooling kits for non-Rittal enclosures

The kits are designed to be used with the IP20/Chassis drives in non-Rittal enclosures for in-back/out-back cooling. Kits do not include plates for mounting in the enclosures.

Ordering number

D3h	176F3519
D4h	176F3524

Ordering number for corrosion resistant

D3h	176F3520
D4h	176F3525

Back-channel cooling kit (in-bottom/out-back)

Kit for directing the back-channel air flow in the bottom of the drive and out the back.

Ordering number

D1h/D3h.....	176F3522
D2h/D4h	176F3527

Ordering number corrosion resistant

D1h/D3h.....	176F3523
D2h/D4h	176F3528

Back-channel cooling kit (in-back/out-back)

These kits are designed to be used for redirecting the back-channel air flow. Factory back-channel cooling directs air in the bottom of the drive and out the top. The kit allows the air to be directed in and out the back of the drive.

Ordering number for in-back/out-back cooling kit

D1h.....	176F3648
D2h	176F3649
D3h	176F3625
D4h	176F3626
D5h/D6h	176F3530
D7h/D8h	176F3531

Ordering number for corrosion resistant

D1h.....	176F3656
D2h	176F3657
D3h	176F3654
D4h	176F3655

Ordering number for VLT® Low Harmonic Drives

D1n	176F6482
D2n	176F6481
E9	176F3538

Ordering number for VLT® Advanced Active Filter AAF 006

D14.....	176F3535
----------	----------

Pedestal kit with in-back/out-back cooling

See additional documents 177R0508 and 177R0509.

Ordering number

D1h 400 mm kit.....	176F3532
D2h 400 mm kit.....	176F3533

Pedestal kit

The pedestal kit is a 400 mm high pedestal for enclosure sizes D1h and D2h, and 200 mm high for enclosure sizes D5h and D6h, that allows the drives to be floor mounted. The front of the pedestal has openings for input air to cool the power components.

Ordering number

D1h 400 mm kit.....	176F3631
D2h 400 mm kit.....	176F3632

D5h/D6h 200 mm kit.....	176F3452
D7h/D8h 200 mm kit.....	176F3539

Input-plate option kit

Input-plate option kits are available for enclosure sizes D and E. The kits can be ordered to add fuses, disconnect/fuses, RFI, RFI/fuses and RFI/disconnect/fuses. Please consult the factory for kit ordering numbers.

Top entry of fieldbus cables

The top entry kit provides the ability to install fieldbus cables through the top of the drive. The kit is IP20 when installed. If an increased rating is desired, a different mating connector can be used.

Ordering number

D3/D4.....	176F1742
D1h-D8h	176F3594

LCP Remote Mounting Kit

The kit makes it possible to detach the LCP from the drive, so it can for example be mounted outside an air handling unit (AHU) for easy operation.

The LCP Remote Mounting Kit offers an easy-to-install, IP54 design which you can mount on panels and walls of 1-90 mm thickness. The front cover blocks the sunlight for convenient programming. The closed cover is lockable to prevent tampering, while keeping the On/Warning/Alarm LEDs visible. The kit is available with 3 m, 5 m or 10 m cable. It is compatible with all VLT® Local Control Panel options.

Ordering number for IP20 enclosure

3 m cable length	134B5223
5 m cable length	134B5224
10 m cable length	134B5225

Multi-wire kit:

The kit is designed to connect the drive with multi-wire cable for each motor phase or mains phase.

Ordering number for IP20 enclosure

D1h.....	176F3817
D2h.....	176F3818

L-shaped busbar kit

The kit allows multi-wires mounting for each phase of mains or motor. D1h, D3h drives can have 3 connections per phase of 50 mm² and D2h, D4h can accommodate 4 connections per phase of 70 mm².

Ordering number for IP20 enclosure

D1h/D3h	
L-shaped motor busbars kit.....	176F3812
D2h/D4h	
L-shaped motor busbars kit.....	176F3810
D1h/D3h	
L-shaped mains busbars kit	176F3854
D2h/D4h	
L-shaped mains busbars kit	176F3855

Common Mode Cores kit:

Designed as a subassembly of 2 or 4 common mode cores to reduce bearing currents. Depending on the voltage and length of the cables, the number of cores change.

Ordering number for IP20 enclosure

Common mode filter	
T5/50m.....	176F6770
Common mode filter	
T5/100m or T7	176F3811



Minimize energy usage while maximizing comfort levels with VLT® HVAC Drive

The VLT® HVAC Drive is installed on a daily basis in various heating, ventilation and air conditioning and water-boosting applications in new and existing buildings and infrastructural systems all over the world.

VLT® drives enhance air quality and indoor comfort levels, improve control and energy-saving possibilities, ensure better asset protection, reduce maintenance costs and increase reliability.

The daily load variation in HVAC facilities is considerable. Variable speed control of electrical motors has proved to be one of the most effective cost-reducing measures available.

World's greenest hotel uses **60% less electricity**

Crowne Plaza Copenhagen Towers Hotel



See the video

EC+ concept drives optimal air conditioning with **20% energy savings**

Volkswagen Navarra, Spain



Read the story

Danfoss and Inertech **change the future** of data centre **cooling**

Inertech, North America



See the video

Discover more case stories for the HVAC industry here: <http://drives.danfoss.com/industries/hvac/case-stories/#/>

Follow us and learn more about AC drives



VLT® | VAGON®

Any information, including, but not limited to information on selection of product, its application or use, product design, weight, dimensions, capacity or any other technical data in product manuals, catalogues descriptions, advertisements, etc. and whether made available in writing, orally, electronically, online or via download, shall be considered informative, and is only binding if and to the extent, explicit reference is made in a quotation or order confirmation. Danfoss cannot accept any responsibility for possible errors in catalogues, brochures, videos and other material. Danfoss reserves the right to alter its products without notice. This also applies to products ordered but not delivered provided that such alterations can be made without changes to form, fit or function of the product. All trademarks in this material are property of Danfoss A/S or Danfoss group companies. Danfoss and the Danfoss logo are trademarks of Danfoss A/S. All rights reserved.